

RIGOL

快速指南

DG1000Z 系列 函数/任意波形发生器

**2017 年 3 月
RIGOL TECHNOLOGIES, INC.**

保证和声明

版权

© 2013 北京普源精电科技有限公司

商标信息

RIGOL 是北京普源精电科技有限公司的注册商标。

文档编号

QGB09006-1110

声明

- 公司产品受中国及其它国家和地区的专利(包括已取得的和正在申请的专利)保护。
- 本公司保留改变规格及价格的权利。
- 本手册提供的信息取代以往出版的所有资料。
- 本手册提供的信息如有变更,恕不另行通知。
- 对于本手册可能包含的错误,或因手册所提供的信息及演绎的功能以及因使用本手册而导致的任何偶然或继发的损失, **RIGOL** 概不负责。
- 未经 **RIGOL** 事先书面许可,不得影印、复制或改编本手册的任何部分。

产品认证

RIGOL 认证本产品符合中国国家产品标准和行业产品标准及 ISO9001:2008 标准和 ISO14001:2004 标准,并进一步认证本产品符合其它国际标准组织成员的相关标准。

联系我们

如您在使用此产品或本手册的过程中有任何问题或需求,可与 **RIGOL** 联系:

电子邮箱: service@rigol.com

网址: www.rigol.com

安全要求

一般安全概要

了解下列安全性预防措施，以避免受伤，并防止损坏本产品或与本产品连接的任何产品。为避免可能的危险，请务必按照规定使用本产品。

使用正确的电源线。

只允许使用所在国家认可的本产品专用电源线。

将产品接地。

本产品通过电源电缆的保护接地线接地。为避免电击，在连接本产品的任何输入或输出端子之前，请确保本产品电源电缆的接地端子与保护接地端可靠连接。

正确连接探头。

如果使用探头，探头地线与地电势相同，请勿将地线连接至高电压。

查看所有终端额定值。

为避免起火和过大电流的冲击，请查看产品上所有的额定值和标记说明，请在连接产品前查阅产品手册以了解额定值的详细信息。

使用合适的过压保护。

确保没有过电压（如由雷电造成的电压）到达该产品。否则操作人员可能有遭受电击的危险。

请勿开盖操作。

请勿在仪器机箱打开时运行本产品。

请勿将异物插入风扇的排风口。

请勿将异物插入风扇的排风口以免损坏仪器。

使用合适的保险丝。

只允许使用本产品指定规格的保险丝。

避免电路外露。

电源接通后，请勿接触外露的接头和元件。

怀疑产品出故障时，请勿进行操作。

如果您怀疑本产品出现故障，请联络**RIGOL**授权的维修人员进行检测。任何维护、调整或零件更换必须由**RIGOL**授权的维修人员执行。

保持适当的通风。

通风不良会引起仪器温度升高，进而引起仪器损坏。使用时应保持良好的通风，定期检查通风口和风扇。

请勿在潮湿环境下操作。

为避免仪器内部电路短路或发生电击的危险，请勿在潮湿环境下操作仪器。

请勿在易燃易爆的环境下操作。

为避免仪器损坏或人身伤害，请勿在易燃易爆的环境下操作仪器。

请保持产品表面的清洁和干燥。

为避免灰尘或空气中的水分影响仪器性能，请保持产品表面的清洁和干燥。

防静电保护。

静电会造成仪器损坏，应尽可能在防静电区进行测试。在连接电缆到仪器前，应将其内外导体短暂接地以释放静电。

正确使用电池。

如果仪器提供电池，严禁将电池暴露于高温或火中。要让儿童远离电池。不正确地更换电池可能造成爆炸（警告：锂离子电池）。必须使用 **RIGOL** 指定的电池。

注意搬运安全。

为避免仪器在搬运过程中滑落，造成仪器面板上的按键、旋钮或接口等部件损坏，请注意搬运安全。

安全术语和符号

本手册中的安全术语。

**警告**

警告性声明指出可能会造成人身伤害或危及生命安全的情况或操作。

**注意**

注意性声明指出可能导致本产品损坏或数据丢失的情况或操作。

产品上的安全术语。

DANGER

表示您如果不进行此操作，可能会立即对您造成危害。

WARNING

表示您如果不进行此操作，可能会对您造成潜在的危害。

CAUTION

表示您如果不进行此操作，可能会对本产品或连接到本产品的其他设备造成损坏。

产品上的安全符号。



高电压



安全警告



保护性接地端



壳体接地端



测量接地端

保养与清洁

保养

请勿将仪器放置在长时间受到日照的地方。

清洁

请根据使用情况经常对仪器进行清洁。方法如下：

1. 断开电源。
2. 用柔和的清洁剂或清水浸湿软布擦拭仪器外部。清洁带有液晶显示屏的仪器时，请注意不要划伤 LCD 显示屏。



注意

请勿使任何腐蚀性的液体沾到仪器上，以免损坏仪器。



警告

重新通电之前，请确认仪器已经干透，避免因水分造成电气短路甚至人身伤害。

环境注意事项

以下符号表明本产品符合 WEEE Directive 2002/96/EC 所制定的要求。



设备回收

本产品中包含的某些物质可能会对环境或人体健康有害，为避免将有害物质释放到环境中或危害人体健康，建议采用适当的方法回收本产品，以确保大部分材料可正确地重复使用或回收。有关处理或回收的信息，请与当地权威机构联系。

文档概述

文档中的格式约定

1. 按键:

本手册中通常用“文本框+文字（加粗）”表示前面板上的一个按键，如 **Sine**。

2. 菜单:

本手册通常用“字符底纹+文字（加粗）”表示一个菜单，如 **频率**。

3. 连接器:

本手册中通常用“方括号+文字（加粗）”表示前面板或后面板上的一个连接器。例如：**[Counter]**。

4. 操作步骤:

本手册中通常用一个箭头“→”表示下一步操作。例如：**Sine** → **频率** 表示按下前面板上的 **Sine** 功能键后再按 **频率** 菜单软键。

文档中的内容约定

- DG1000Z 系列函数/任意波形发生器包含 DG1022Z、DG1032Z 和 DG1062Z 三个型号。本手册以 DG1062Z 为例，介绍其基本操作。有关更多详细信息，请参考《DG1000Z 系列函数/任意波形发生器用户手册》。

型号	通道数	最大输出频率
DG1062Z	2	60MHz
DG1032Z	2	30MHz
DG1022Z	2	25MHz

- DG1000Z 系列函数/任意波形发生器均具有 CH1 和 CH2 两个通道。本文如无特殊说明，均以 CH1 为例介绍信号发生器的操作方法。CH2 的操作方法与 CH1 相同。

本产品用户文档

本产品的主要用户文档包括快速指南、用户手册、编程手册、数据手册等。用户可以登录 **RIGOL** 官网（www.rigol.com）下载所需文档的最新版本。

目录

保证和声明.....	I
安全要求.....	II
一般安全概要.....	II
安全术语和符号.....	III
保养与清洁.....	IV
环境注意事项.....	IV
文档概述.....	V
快速入门.....	1
一般性检查.....	1
调整手柄.....	2
外观尺寸.....	3
前面板概述.....	4
后面板概述.....	9
开机检查.....	11
连接电源.....	11
开机.....	11
设置系统语言.....	11
用户界面.....	12
双通道参数模式.....	12
双通道图形模式.....	14
单通道显示模式.....	14
使用内置帮助系统.....	15
基本操作.....	16
输出基本波形.....	16
输出任意波.....	18
输出谐波.....	19
输出 AM 已调波形.....	20
输出 FSK 已调波形.....	22
输出 Sweep 波形.....	23
输出 Burst 波形.....	24
远程控制.....	25
故障处理.....	27
更多产品信息.....	28
联系我们.....	28

快速入门

一般性检查

1. 检查运输包装

如运输包装已损坏，请保留被损坏的包装或防震材料，直到货物经过完全检查且仪器通过电性和机械测试。

因运输造成仪器损坏，由发货方和承运方联系赔偿事宜。**RIGOL** 公司恕不进行免费维修或更换。

2. 检查整机

若存在机械损坏或缺失，或者仪器未通过电性和机械测试，请联系您的 **RIGOL** 经销商。

3. 检查随机附件

请根据装箱单检查随机附件，如有损坏或缺失，请联系您的 **RIGOL** 经销商。

调整手柄

要调整仪器的手柄，请握住仪器两侧的手柄并向外拉。然后将手柄旋转到所需位置。操作方法如下图所示。

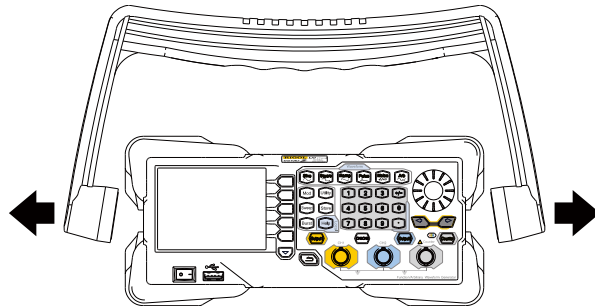

调整手柄

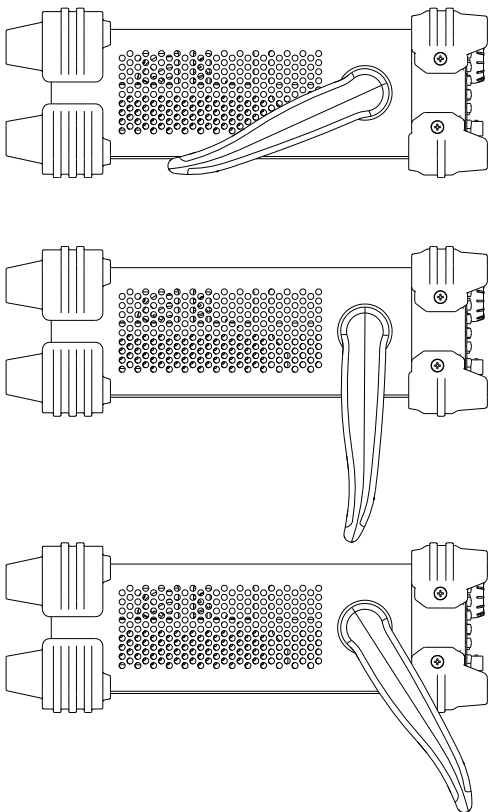

平放位置

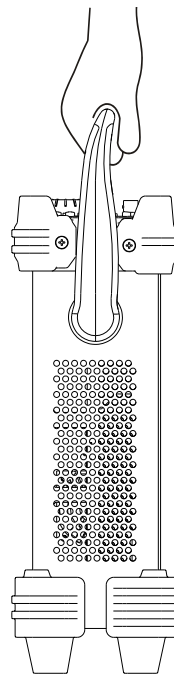

移动位置

外观尺寸

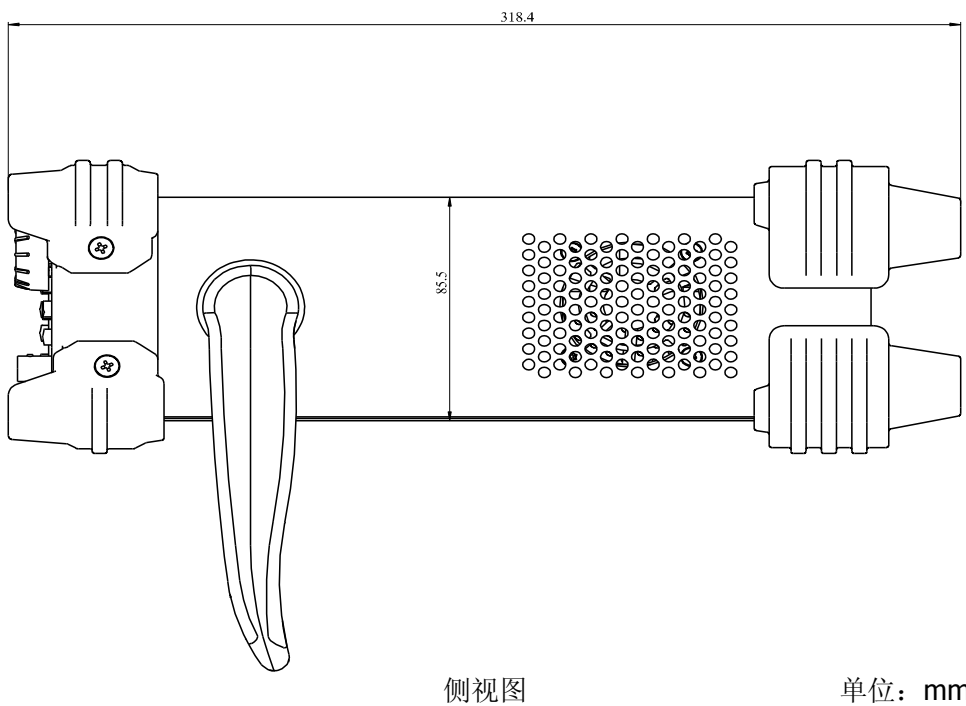
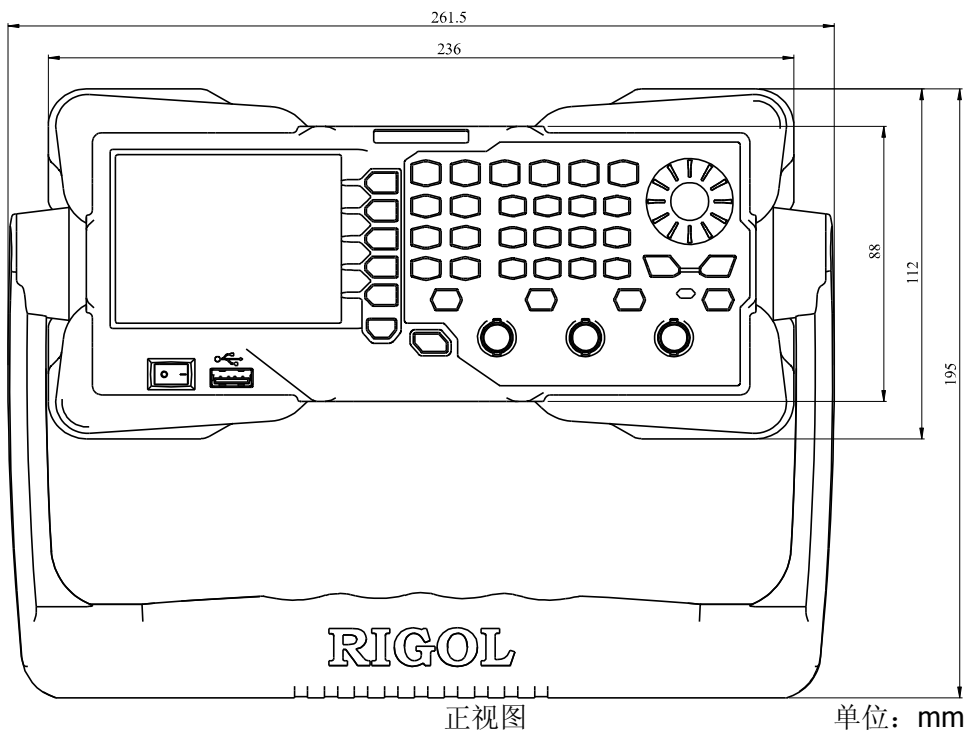

前面板概述



图 1 前面板

1. 电源键

用于开启或关闭信号发生器。

2. USB Host

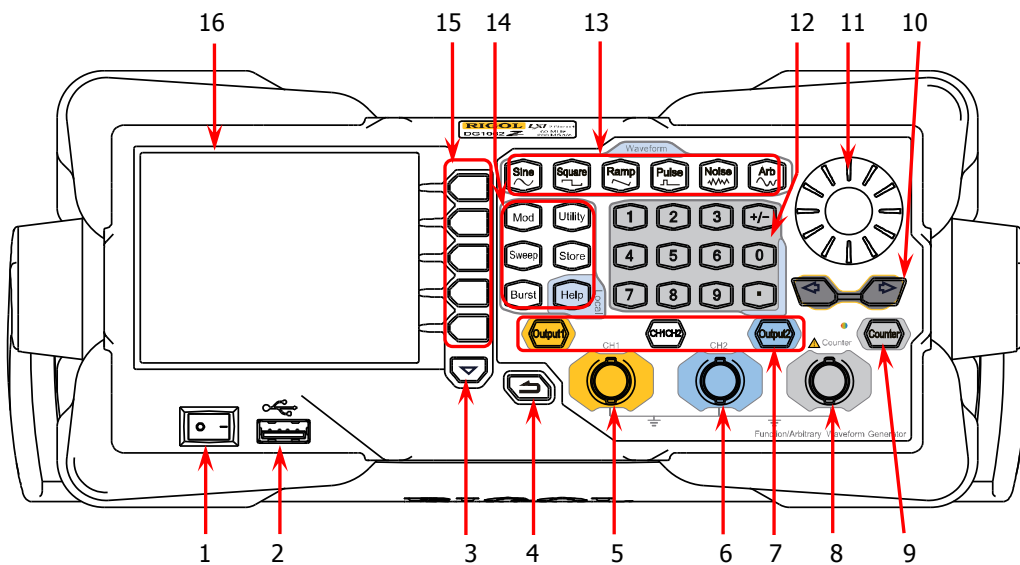
支持 FAT32 格式 Flash 型 U 盘、**RIGOL** TMC 数字示波器、功率放大器（选件）和 USB-GPIB 模块（选件）。

- U 盘：读取 U 盘中的波形文件或状态文件，或将当前的仪器状态或编辑的波形数据存储到 U 盘中，也可以将当前屏幕显示的内容以图片格式 (*.Bmp) 保存到 U 盘。
- TMC 数字示波器：与符合 TMC 标准的 **RIGOL** 示波器进行无缝互联，读取并存储示波器中采集到的波形，再无损地重现出来。
- 功率放大器（选件）：支持 **RIGOL** 功率放大器（如：PA1011），对其进行在线配置，将信号功率放大后输出。
- USB-GPIB 模块（选件）：为集成了 USB Host 接口但未集成 GPIB 接口的 **RIGOL** 仪器扩展出 GPIB 接口。

3. 菜单翻页键

打开当前菜单的下一页。

4. 返回上一级菜单

退出当前菜单，并返回上一级菜单。

5. CH1 输出连接器

BNC 连接器，标称输出阻抗为 50Ω 。

当 **Output1** 打开时（背灯变亮），该连接器以 CH1 当前配置输出波形。

6. CH2 输出连接器

BNC 连接器，标称输出阻抗为 50Ω 。

当 **Output2** 打开时（背灯变亮），该连接器以 CH2 当前配置输出波形。

7. 通道控制区



用于控制 CH1 的输出。

- 按下该按键，背灯变亮，打开 CH1 输出。此时，**[CH1]** 连接器以当前配置输出信号。
- 再次按下该键，背灯熄灭，此时，关闭 CH1 输出。



用于控制 CH2 的输出。

- 按下该按键，背灯变亮，打开 CH2 输出。此时，**[CH2]** 连接器以当前配置输出信号。
- 再次按下该键，背灯熄灭，此时，关闭 CH2 输出。



用于切换 CH1 或 CH2 为当前选中通道。



注意

CH1 和 CH2 通道输出端设有过压保护功能，满足下列条件之一则产生过压保护。产生过压保护时，屏幕弹出提示消息，输出关闭。

- 仪器幅度设置大于 $2V_{pp}$ 或输出偏移大于 $|2V_{DC}|$ ，输入电压大于 $\pm 11.5 \times (1 \pm 5\%)V$ ($< 10kHz$)。
- 仪器幅度设置小于等于 $2V_{pp}$ 或输出偏移小于等于 $|2V_{DC}|$ ，输入电压大于 $\pm 3.5 \times (1 \pm 5\%)V$ ($< 10kHz$)。

8. Counter 测量信号输入连接器

BNC 连接器，输入阻抗为 $1M\Omega$ 。用于接收频率计测量的被测信号。



注意

为了避免损坏仪器，输入信号的电压范围不得超过 $\pm 7V_{ac+dc}$ 。

9. 频率计

用于开启或关闭频率计功能。

- 按下该按键，背灯变亮，左侧指示灯闪烁，频率计功能开启。
- 再次按下该键，背灯熄灭，此时，关闭频率计功能。

注意：当 Counter 打开时，CH2 的同步信号将被关闭；关闭 Counter 后，CH2 的同步信号恢复。

10. 方向键

- 使用旋钮设置参数时，用于移动光标以选择需要编辑的位；
- 使用键盘输入参数时，用于删除光标左边的数字。
- 存储或读取文件时，用于展开或收起当前选中目录。
- 文件名编辑时，用于移动光标选择文件名输入区中指定的字符。

11. 旋钮

- 使用旋钮设置参数时，用于增大（顺时针）或减小（逆时针）当前光标处的数值。
- 存储或读取文件时，用于选择文件保存的位置或用于选择需要读取的文件。
- 文件名编辑时，用于选择虚拟键盘中的字符。
- 在 **Arb** → **选择波形** → **内建波形** 中，用于选择所需的内建任意波。

12. 数字键盘

包括数字键（0 至 9）、小数点（.）和符号键（+/-），用于设置参数。

注意：

- 编辑文件名时，符号键用于切换大小写。
- 连续按两次小数点可将用户界面以*.Bmp 格式快速保存至 U 盘。

13. 波形键



提供频率从 1 μ Hz 至 60MHz 的正弦波输出。

- 选中该功能时，按键背灯变亮。
- 可以设置正弦波的频率/周期、幅度/高电平、偏移/低电平和起始相位。



提供频率从 1 μ Hz 至 25MHz 并具有可变占空比的方波输出。

- 选中该功能时，按键背灯变亮。
- 可以设置方波的频率/周期、幅度/高电平、偏移/低电平、占空比和起始相位。



提供频率从 1 μ Hz 至 1MHz 并具有可变对称性的锯齿波输出。

- 选中该功能时，按键背灯变亮。
- 可以设置锯齿波的频率/周期、幅度/高电平、偏移/低电平、对称性和起始相位。



提供频率从 1 μ Hz 至 25MHz 并具有可变脉冲宽度和边沿时间的脉冲波输出。

- 选中该功能时，按键背灯变亮。
- 可以设置脉冲波的频率/周期、幅度/高电平、偏移/低电平、脉宽/占空比、上升沿、下降沿和起始相位。



提供带宽为 60MHz 的高斯噪声输出。

- 选中该功能时，按键背灯变亮。
- 可以设置噪声的幅度/高电平和偏移/低电平。



提供频率从 1 μ Hz 至 20MHz 的任意波输出。

- 支持采样率和频率两种输出模式。
- 多达 160 种内建波形。
- 选中该功能时，按键背灯变亮。
- 可设置任意波的频率/周期、幅度/高电平、偏移/低电平和起始相位。

14. 功能键



可输出多种已调制的波形。

- 提供多种调制方式：AM、FM、PM、ASK、FSK、PSK 和 PWM。
- 支持内部和外部调制源。
- 选中该功能时，按键背灯变亮。



可产生正弦波、方波、锯齿波和任意波（DC 除外）的 Sweep 波形。

- 支持线性、对数和步进 3 种 Sweep 方式。
- 支持内部、外部和手动 3 种触发源。
- 提供频率标记功能，用于控制同步信号的状态。
- 选中该功能时，按键背灯变亮。



可产生正弦波、方波、锯齿波、脉冲波和任意波（DC 除外）的 Burst 波形。

- 支持 N 循环、无限和门控 3 种 Burst 模式。
- 噪声也可用于产生门控 Burst。
- 支持内部、外部和手动 3 种触发源。
- 选中该功能时，按键背灯变亮。



用于设置辅助功能参数和系统参数。选中该功能时，按键背灯变亮。



可存储或调用仪器状态或者用户编辑的任意波数据。

- 内置一个非易失性存储器(C 盘), 并可外接一个 U 盘(D 盘)。
- 选中该功能时，按键背灯变亮。



要获得任何前面板按键或菜单软键的帮助信息，按下该键后，再按下你所需要获得帮助的按键。

注意：

- 1) 当仪器工作在远程模式时，该键用于返回本地模式。

- 2) 该键可用于锁定和解锁键盘。长按 **Help** 键，可锁定前面板按键，此时，除 **Help** 键，前面板其它按键不可用。再次长按该键，可解除锁定。

15. 菜单软键

与其左侧显示的菜单一一对应，按下该软键激活相应的菜单。

16. LCD 显示屏

3.5 英寸 TFT (320×240) 彩色液晶显示屏，显示当前功能的菜单和参数设置、系统状态以及提示消息等内容，详细信息请参考“用户界面”一节。

后面板概述



图 2 后面板

1. CH1 同步/外调制/触发连接器: [CH1/Sync/Ext Mod/Trig/FSK]

BNC 母头连接器，标称阻抗为 50Ω ，其功能由 CH1 当前的工作模式决定。

- **Sync:** 打开 CH1 输出时，该连接器输出与 CH1 当前配置相匹配的同步信号。
- **Ext Mod:** 若 CH1 开启 AM、FM、PM 或 PWM 并且使用外部调制源，该连接器接收一个来自外部的调制信号。
- **FSK:** 若 CH1 开启 ASK、FSK 或 PSK 并且使用外部调制源，该连接器接收一个来自外部的调制信号（可设置该信号的极性）。
- **Trig In:** 若 CH1 开启 Sweep 或 Burst 功能并且使用外部触发源，该连接器接收一个来自外部的触发信号（可设置该信号的极性）。
- **Trig Out:** 若 CH1 开启 Sweep 或 Burst 功能并且使用内部或手动触发源，该连接器输出具有指定边沿的触发信号。

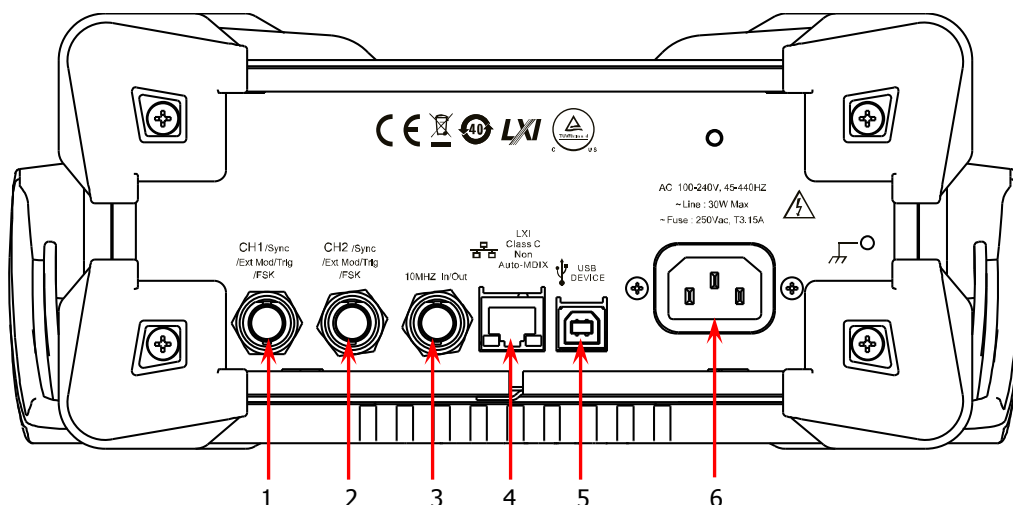
有关上述各信号的更多详细信息，请参考本产品用户手册。

2. CH2 同步/外调制/触发连接器: [CH2/Sync/Ext Mod/Trig/FSK]

BNC 母头连接器，标称阻抗为 50Ω ，其功能由 CH2 当前的工作模式决定。

- **Sync:** 打开 CH2 输出时，该连接器输出与 CH2 当前配置相匹配的同步信号。
- **Ext Mod:** 若 CH2 开启 AM、FM、PM 或 PWM 且使用外部调制源，该连接器接收一个来自外部的调制信号。
- **FSK:** 若 CH2 开启 ASK、FSK 或 PSK 且使用外部调制源，该连接器接收一个来自外部的调制信号（可设置该信号的极性）。
- **Trig In:** 若 CH2 开启 Sweep 或 Burst 功能且使用外部触发源，该连接器接收一个来自外部的触发信号（可设置该信号的极性）。
- **Trig Out:** 若 CH2 开启 Sweep 或 Burst 功能且使用内部或手动触发源，该连接器输出具有指定边沿的触发信号。

有关上述各信号的更多详细信息，请参考本产品用户手册。

3. 10MHz 输入/输出连接器: [10MHz In/Out]

BNC 母头连接器，标称阻抗为 50Ω ，其功能由仪器使用的时钟类型决定。

- 若仪器使用内部时钟源，该连接器（用作 10MHz Out）可输出由仪器内部晶振产生的 10MHz 时钟信号。
- 若仪器使用外部时钟源，该连接器（用作 10MHz In）接收一个来自外部的 10MHz 时钟信号。

该连接器通常用于在多台仪器之间建立同步。有关上述各信号的更多详细信息，请参考本产品用户手册。

4. LAN 接口

用于将信号发生器连接至计算机或计算机所在的网络，进行远程控制。本信号发生器符合 LXI Core 2011 Device 类仪器标准，可与其他标准设备快速搭建测试系统，轻松实现系统集成。

5. USB Device 接口

用于与计算机连接，通过上位机软件或用户自定义编程对信号发生器进行控制。还可与 PictBridge 打印机连接，打印屏幕显示的内容。

6. AC 电源插口

本信号发生器支持的交流电源规格为 100-240V，45-440Hz，最大输入功率不可超过 30W。电源保险丝规格为 250V，T3.15A。

开机检查

连接电源

请使用附件提供的电源线将信号发生器连接至 AC 电源中，如下图所示。本信号发生器支持 100-240V，45-440Hz 规格的交流电源。最大输入功率不可超过 30W。当通过该连接器将信号发生器连接到交流电源时，仪器自动调节至正确的电压范围，无需手动选择电压范围。





图 3 连接电源

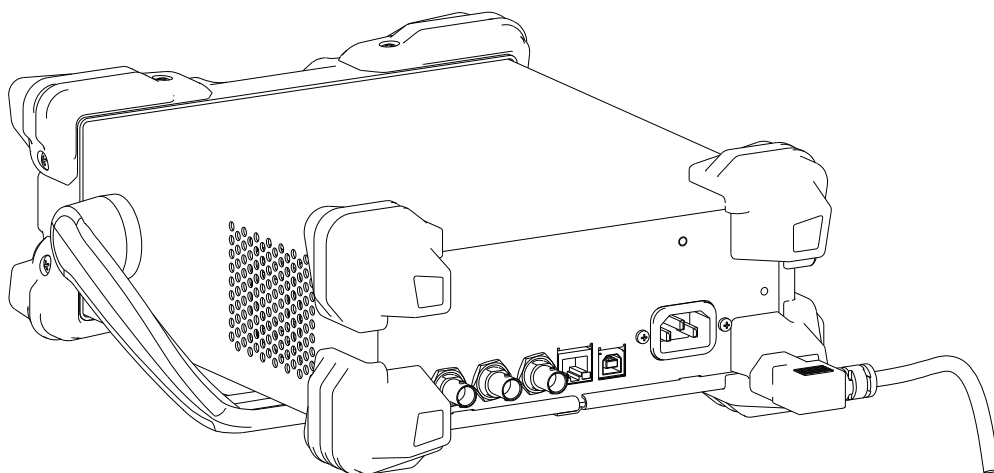

注意

为避免电击，请确保仪器正确接地。

开机

正确连接电源后，按下前面板的电源键  打开信号发生器。开机过程中仪器执行初始化过程和自检过程。结束后，屏幕进入默认界面。如无法正常开机，请参考“故障处理”一节处理。

设置系统语言

DG1000Z 系列函数/任意波形发生器支持多种语言菜单。您可以按 **Utility** → **Language**，选择所需的语言类型。

用户界面

DG1000Z 的用户界面包括三种显示模式：双通道参数（默认）、双通道图形和单通道显示。本手册着重以双通道参数显示模式为例介绍仪器的用户界面。

双通道参数模式



图 4 用户界面（双通道参数模式）

1. 通道输出配置状态栏

显示各通道当前的输出配置。

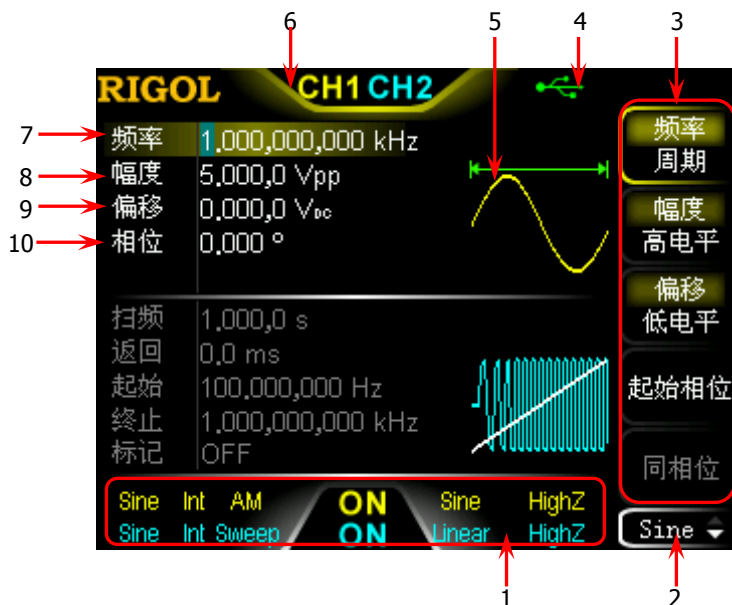
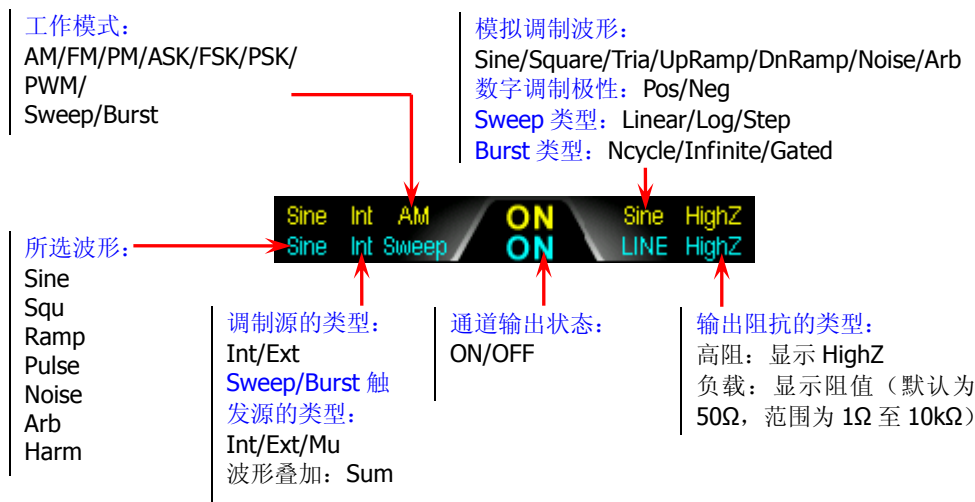

2. 当前功能及翻页提示

显示当前已选中功能的名称。例如：“Sine”表示当前选中正弦波功能，“Edit”表示当前选中任意波编辑功能。此外，功能名称右侧的上、下箭头用来提示当前是否可执行翻页操作。

3. 菜单

显示当前已选中功能对应的操作菜单。

4. 状态栏



：仪器正确连接至局域网时显示。



：仪器工作于远程模式时显示。



：仪器前面板被锁定时显示。



：仪器检测到 U 盘时显示。



：仪器与功率放大器正确连接时显示。

5. 波形

显示各通道当前选择的波形。

6. 通道状态栏

指示当前通道的选中状态和开关状态。选中 CH1 时，状态栏边框显示黄色；选中 CH2 时，状态栏边框显示蓝色；打开 CH1 时，状态栏中“CH1”以黄色高亮显示；打开 CH2 时，状态栏中“CH2”以蓝色高亮显示。

注意：可以同时打开两个通道，但不可同时选中两个通道。

7. 频率

显示各通道当前波形的频率。按相应的 **频率/周期** 使“频率”突出显示，通过数字键盘或方向键和旋钮改变该参数。

8. 幅度

显示各通道当前波形的幅度。按相应的 **幅度/高电平** 使“幅度”突出显示，通过数字键盘或方向键和旋钮改变该参数。

9. 偏移

显示各通道当前波形的直流偏移。按相应的 **偏移/低电平** 使“偏移”突出显示，通过数字键盘或方向键和旋钮改变该参数。

10. 相位

显示各通道当前波形的相位。按相应的 **起始相位** 菜单后，通过数字键盘或方向键和旋钮改变该参数。

双通道图形模式

按 **Utility** → 系统设置 → 显示设置 → 显示模式 选择“双通道图形”即可切换为双通道图形显示模式，如下图所示。



图 5 用户界面（双通道图形模式）

单通道显示模式

按 **Utility** → 系统设置 → 显示设置 → 显示模式 选择“单通道显示”即可切换为单通道显示模式，如下图所示。

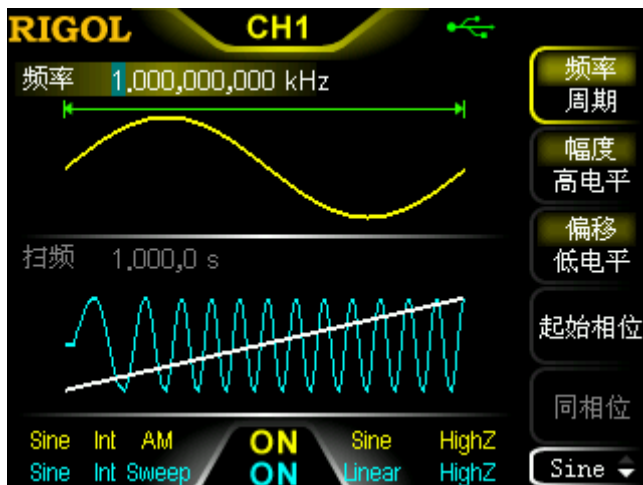

图 6 用户界面（单通道显示模式）

使用内置帮助系统

DG1000Z 内置帮助系统对于前面板上的每个功能按键和菜单软键都提供了帮助信息。用户可在操作仪器的过程中随时查看任意键的帮助信息。

1. 获取内置帮助的方法

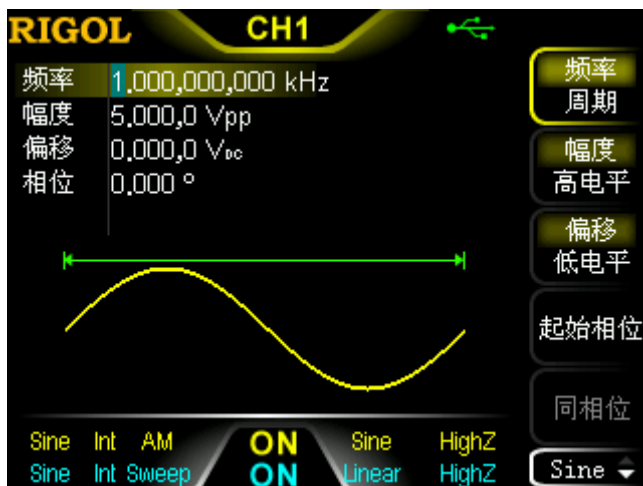
按下 **Help** 键，背灯点亮，然后再按下你所需要获得帮助的功能按键或菜单软键，仪器界面显示该键的帮助信息。

2. 帮助的翻页操作

当帮助信息为多页显示时，通过菜单软键 **▲**(上一行)/**▼**(下一行)/**▲**(上一页)/**▼**(下一页) 或旋钮可滚动帮助信息页面。

3. 关闭当前的帮助信息

当仪器界面显示帮助信息时，用户按下前面板上的返回键 ，将关闭当前显示的帮助信息并跳转到相应的功能界面。

4. 常用帮助主题

连续按两次 **Help** 键打开常用帮助主题列表。此时，您可通过按 **▲**/**▼**/**▲**/**▼** 菜单软键或旋转旋钮滚动列表，然后按 **选择** 选中相应的帮助信息进行查看。

基本操作

输出基本波形

DG1000Z 可从单通道或同时从双通道输出基本波形，包括正弦波、方波、锯齿波、脉冲和噪声。本节主要介绍如何从 **[CH1]** 连接器输出一个正弦波（频率为 20kHz，幅度为 2.5Vpp，偏移量为 500mVDC，起始相位为 90°）。

1. 选择输出通道

按通道选择键 **[CH1|CH2]** 选中 CH1。此时通道状态栏边框以黄色标识。

2. 选择正弦波

按 **[Sine]** 选择正弦波，背灯变亮表示功能选中，屏幕右方出现该功能对应的菜单。

3. 设置频率/周期

按 **频率/周期** 使“频率”突出显示，通过数字键盘输入 20，在弹出的菜单中选择单位 kHz。

- 频率范围为 1μHz 至 60MHz。
- 可选的频率单位有：MHz、kHz、Hz、mHz、μHz。
- 再次按下此软键切换至周期的设置。
- 可选的周期单位有：sec、msec、μsec、nsec。

4. 设置幅度

按 **幅度/高电平** 使“幅度”突出显示，通过数字键盘输入 2.5，在弹出的菜单中选择单位 Vpp。

- 幅度范围受阻抗和频率/周期设置的限制。
- 可选的幅度单位有：Vpp、mVpp、Vrms、mVrms、dBm（仅当 **[Utility]** → **通道设置** → **输出设置** → **阻抗** 为非高阻时，dBm 有效）。
- 再次按下此软键切换至高电平设置。
- 可选的高电平单位有：V、mV。

5. 设置偏移电压

按 **偏移/低电平** 使“偏移”突出显示，通过数字键盘输入 500，在弹出的菜单中选择单位 mVDC。

- 偏移范围受阻抗和幅度/高电平设置的限制。
- 可选的偏移单位有：VDC、mVDC。
- 再次按下此软键切换至低电平设置。低电平应至少比高电平小 1mV（输出阻抗为 50Ω 时）。
- 可选的低电平单位有：V、mV。

6. 设置起始相位

按 **起始相位**，通过数字键盘输入 90，在弹出的菜单中选择单位 °。起始相位值

范围为 0° 至 360° 。

7. 启用输出

按 **Output1** 键，背灯变亮，**[CH1]** 连接器以当前配置输出正弦波信号。

8. 观察输出波形

使用 BNC 连接线将 DG1000Z 的**[CH1]**与示波器相连接，下图为由示波器观察到的波形。



图 7 正弦波

输出任意波

DG1000Z 可从单通道或同时从双通道输出仪器内建或用户自定义的任意波形。本节主要介绍如何从 **[CH1]** 连接器输出一个用户自定义的任意波（点编辑，采样率编辑模式，高电平：4V，低电平：-2V，初始化点数：8，点 1 至点 4 的电压：4V，点 5 至点 8 的电压：-2V）。

1. 选择输出通道

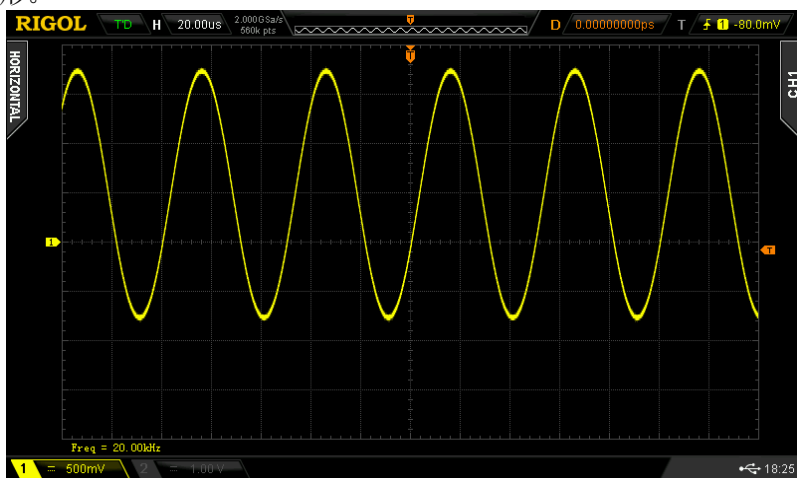
按通道选择键 **CH1|CH2** 选中 CH1。此时通道状态栏边框以黄色标识。

2. 启用任意波功能

按 **Arb** 键进入任意波设置界面。请先参考“输出基本波形”一章的介绍设置任意波的频率、幅度、偏移和相位等参数。

3. 编辑任意波

按 **Arb** → **编辑波形** 打开任意波编辑菜单。

- 1) 按 **模式** 选择“采样率”。
- 2) 按 **高电平**，使用数字键盘输入 4，并在弹出的菜单中选择单位 V。
- 3) 按 **低电平**，使用数字键盘输入 -2，并在弹出的菜单中选择单位 V。
- 4) 按 **点数**，使用数字键盘输入 8 后按 **确认**。此时出现一条 -2 V 的电平线。
- 5) 按 **点编辑**，进入点编辑界面。
 - 按 **编辑点**，开始定义第一个点。直接按 **电压** 软键，使用数字键盘输入 4，并在弹出的菜单中选择单位 V。
 - 再次按 **编辑点**，使用数字键盘或旋钮选择点 2，然后按 **电压**，输入 4V。
 - 使用上述方法输入点 3 至 8 的电压值。

4. 选择波形

按 **Arb** → **选择波形** → **易失波形** 选择已编辑的波形。

5. 启用输出

按 **Output1** 键，背灯变亮，**[CH1]** 连接器以当前配置输出已编辑的任意波。

6. 观察输出波形

使用 BNC 连接线将 DG1000Z 的 **[CH1]** 连接器与示波器相连接，此时，可通过示波器观察波形。

输出谐波

DG1000Z 可作为一款谐波发生器，输出具有指定次数、幅度和相位的谐波。本节将介绍从 **[CH1]** 连接器输出 2 次谐波和 4 次谐波，谐波幅度分别为 2Vpp 和 1Vpp，谐波相位分别为 30° 和 50°，谐波次数设为 5。

1. 选择输出通道

按通道选择键 **CH1|CH2** 选中 CH1。此时通道状态栏边框以黄色标识。

2. 设置基波参数

请参考“输出基本波形”一章的介绍设置基波的频率/周期、幅度/高电平、偏移/低电平、起始相位等参数。

3. 启用谐波功能

按 **Sine** → **谐波** 选择“打开”。按 **谐波参数** 进入谐波设置菜单。

4. 设置谐波次数

在谐波设置菜单中，按 **次数**，使用数字键盘输入 5，按 **确认**。

- 谐波次数的可设置范围受仪器最大输出频率和当前的基波频率限制。
- 范围：2 至 $\text{仪器最大输出频率} \div \text{基波频率}$ ，且为整数。最大值为 8。

5. 选择谐波类型

在谐波设置菜单中，按 **谐波类型** 选择偶次谐波或自定义。

方法一：偶次谐波

按下该软键，仪器输出基波和偶次谐波（2 和 4 次谐波）。

方法二：自定义

按下该软键，用户可自定义输出谐波的次数，最高次数为 8。

使用 8 位二进制数据分别代表 8 次谐波的输出状态，1 表示打开相应次谐波的输出，0 表示关闭相应次谐波的输出。用户只需使用数字键盘修改各数据位的数值即可（注意，最左侧的位表示基波，固定为 X，不允许修改）。例如：将 8 位数据设置为 X101 0000，表示输出 2 和 4 次谐波。

注意：实际输出的谐波受当前指定的谐波次数和谐波类型共同限制。

6. 设置谐波幅度

在谐波设置菜单中，按 **谐波幅度** 软键依次设置 2 和 4 次谐波的幅度。

- 1) 按下 **序号**，使用数字键盘输入 2，按 **确认**。
- 2) 按下 **谐波幅度**，使用数字键盘输入幅度的数值 2，在弹出的单位菜单中选择单位 Vpp。
- 3) 参考步骤 1) 和 2) 设置 4 次谐波的幅度为 1Vpp。

7. 设置谐波相位

在谐波设置菜单中，按 **谐波相位** 依次设置 2 和 4 次谐波的相位。

- 1) 按下 **序号**，使用数字键盘输入待设置谐波的序号 2，按 **确认**。
- 2) 按下 **谐波相位**，使用数字键盘输入相位的数值 30，然后在弹出的单位菜单中选择单位°。
- 3) 参考步骤 1)和 2)设置 4 次谐波的相位为 50°。

8. 启用输出

按 **Output1** 键，背灯变亮，**[CH1]** 连接器以当前配置输出基波、2 次和 4 次谐波。

9. 观察输出波形

使用 BNC 连接线将 DG1000Z 的 **[CH1]** 连接器与示波器相连接，下图为由示波器观察到的波形。



图 8 谐波

输出 AM 已调波形

对于幅度调制 (AM)，载波的幅度随调制波的瞬时电压而变化。本节介绍从 **[CH1]** 连接器输出一个 AM 已调波形(载波为 5kHz 的正弦波，幅度为 5Vpp；调制波形为 200Hz 的正弦波，调制深度为 80%)。

1. 选择输出通道

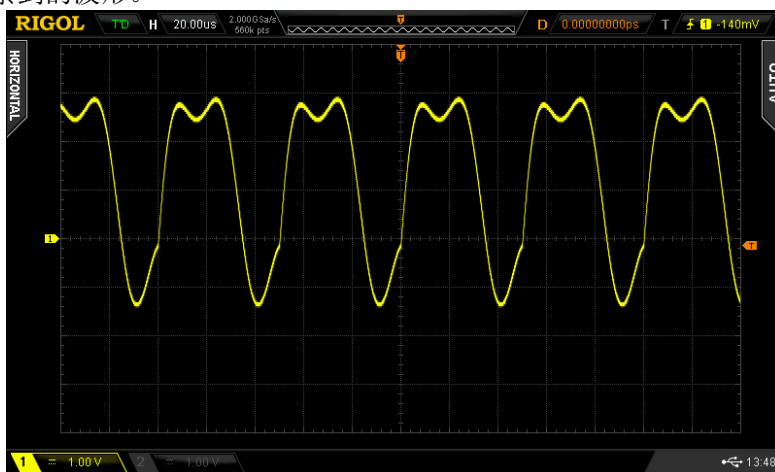
按通道选择键 **CH1|CH2** 选中 CH1。此时通道状态栏边框以黄色标识。

2. 设置载波波形、频率和幅度

- 1) 载波波形：按 **Sine** 选择正弦波作为载波波形。
- 2) 载波频率：按 **频率/周期** 软键使“频率”突出显示，此时通过数字键盘输入 5，然后在弹出的菜单中选择单位 kHz。
- 3) 载波幅度：按 **幅度/高电平** 软键使“幅度”突出显示，此时通过数字键盘输入 5，然后在弹出的菜单中选择单位 Vpp。

3. 选择 AM 调制

按 **Mod** → **类型** → **AM** 键，启用 AM 功能。

- 启用 **Mod** 时，**Sweep** 或 **Burst** 功能将自动关闭（如果当前已打开）。
- 屏幕下方显示相应配置信息：**Int** 和 **AM**。

4. 设置调制波频率

按 **调制频率** 软键，使用数字键盘输入所需的频率值 **200**，然后在弹出的单位菜单中选择所需的单位 **Hz**。

5. 选择调制波形

按 **调制波形** 软键，在弹出的波形菜单中选择 **Sine**。

6. 设置调制深度

按 **调制深度** 软键，使用数字键盘输入调制深度数值 **80**，然后在弹出的单位菜单中选择所需的单位 **%**。

7. 启用输出

按 **Output1** 键，背灯变亮，**[CH1]** 连接器以当前配置输出 AM 已调制波形。

8. 观察输出波形

使用 BNC 连接线将 DG1000Z 的 **[CH1]** 连接器与示波器相连接，下图为由示波器观察到的波形。



图 9 AM 已调波形

输出 FSK 已调波形

FSK 调制时，信号发生器在两个预置频率（载波频率和跳频频率）间“移动”其输出频率。本节将介绍从 [CH1] 连接器输出一个 FSK 波形（载波为 3kHz 的正弦波，幅度为 5Vpp；跳跃频率为 500Hz，调制速率为 100Hz，调制极性为正极性）。

1. 选择输出通道

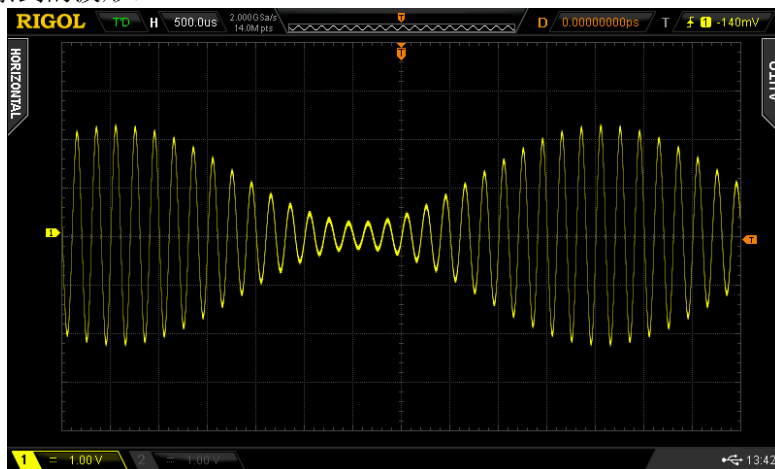
按通道选择键 **CH1|CH2** 选中 CH1。此时通道状态栏边框以黄色标识。

2. 设置载波波形、频率和幅度

- 1) 载波波形：按 **Sine** 选择正弦波作为载波波形。
- 2) 载波频率：按 **频率/周期** 软键使“频率”突出显示，此时通过数字键盘输入 3，然后在弹出的菜单中选择单位 kHz。
- 3) 载波幅度：按 **幅度/高电平** 软键使“幅度”突出显示，此时通过数字键盘输入 5，然后在弹出的菜单中选择单位 Vpp。

3. 选择 FSK 调制

按 **Mod** → **类型** → **FSK** 键，启用 FSK 功能。

- 启用 **Mod** 时，**Sweep** 或 **Burst** 功能将自动关闭（如果当前已打开）。
- 屏幕下方显示相应配置信息：**Int** 和 **FSK**。

4. 设置跳跃频率

按 **跳跃频率** 软键，使用数字键盘输入所需的频率值 500，然后在弹出的单位菜单中选择所需的单位 Hz。

5. 设置调制速率

按 **调制速率** 软键，使用数字键盘输入所需的频率值 100，然后在弹出的单位菜单中选择所需的单位 Hz。

6. 设置调制极性

按 **极性** 软键，选择调制波的正极性控制频率输出。此时，在调制波幅度为逻辑低电平时输出载波频率，逻辑高电平时输出跳频频率。

7. 启用输出

按 **Output1** 键，背灯变亮，[CH1] 连接器以当前配置输出 FSK 波形。

8. 观察输出波形

使用 BNC 连接线将 DG1000Z 的 [CH1] 连接器与示波器相连接，此时，可通过示波器观察波形。

输出 Sweep 波形

DG1000Z 可从单通道或同时从双通道输出 Sweep 波形。本节介绍如何从 [CH1] 连接器输出 Sweep 波形（线性扫描，载波为正弦波，幅度为 5Vpp，频率范围为 50Hz~1kHz，扫描时间为 1s，内部触发源）。

1. 选择输出通道

按通道选择键 **CH1|CH2** 选中 CH1。此时通道状态栏边框以黄色标识。

2. 设置 Sweep 的载波波形和幅度

- 1) 波形：按 **Sine** 选择正弦波作为载波波形。
- 2) 幅度：按 **幅度/高电平** 软键使“幅度”突出显示，此时通过数字键盘输入 5，然后在弹出的菜单中选择单位 Vpp。

3. 开启 Sweep 功能

按前面板的 **Sweep** 键，背灯变亮，表示启用 Sweep 功能。

- 启用 **Sweep** 时，**Mod** 或 **Burst** 功能将自动关闭（如果当前已打开）。
- 屏幕下方显示相应配置信息：**Int** 和 **Sweep**。

4. 选择扫描类型

按 **类型** 软键选择线性。此时，界面中的波形上出现一条白色直线，表示线性扫描类型，如右图所示。



5. 设置起始频率和终止频率

- 1) 起始频率
按 **起始/中心**，使“起始”突出显示，使用数字键盘输入所需的频率值 50，然后在弹出的单位菜单中选择单位 Hz。
- 2) 终止频率
按 **终止/跨度**，使“终止”突出显示，使用数字键盘输入所需的频率值 1，然后在弹出的单位菜单中选择单位 kHz。

6. 设置扫描时间

按 **扫描时间**，使用数字键盘输入所需的时间值 1，在弹出的菜单中选择单位 sec。

7. 选择触发源

按 **触发** → **触发源**，选择内部触发源。

8. 启用输出

按 **Output1** 键，背灯变亮，[CH1] 连接器以当前配置输出 Sweep 波形。

9. 观察输出波形

使用 BNC 连接线将 DG1000Z 的 [CH1] 连接器与示波器相连接，此时，可通过示波器观察波形。

输出 Burst 波形

DG1000Z 可从单通道或同时从双通道输出具有指定循环数目的波形（称为 Burst）。本节介绍如何从 [CH1] 连接器输出 Burst 波形（3 个循环，载波为正弦波，幅度为 5Vpp，周期为 1ms，猝发周期为 10ms，内部触发源，延时：1ms）。

1. 选择输出通道

按通道选择键 **CH1|CH2** 选中 CH1。此时通道状态栏边框以黄色标识。

2. 设置 Burst 的载波波形、幅度和周期

- 1) 波形：按 **Sine** 选择正弦波作为载波波形。
- 2) 幅度：按 **幅度/高电平** 使“幅度”突出显示，通过数字键盘输入 5，然后在弹出的菜单中选择单位 Vpp。
- 3) 周期：按 **频率/周期** 使“周期”突出显示，通过数字键盘输入 1，然后在弹出的菜单中选择单位 msec。

3. 开启 Burst 功能

按前面板的 **Burst** 键，背灯变亮，表示启用 Burst 功能。

- 启用 **Burst** 时，**Mod** 或 **Sweep** 功能将自动关闭（如果当前已打开）。
- 屏幕下方显示相应配置信息：**Int** 和 **Burst**。

4. 设置 Burst 类型和循环数

按 **类型**，选择 N 循环。屏幕中循环数参数突出显示，处于可编辑状态，此时使用数字键盘输入循环次数 3，然后按 **确认** 软键。

5. 设置 Burst 周期

Burst 周期仅适用于 N 循环类型，是指从一个 Burst 开始到下一个 Burst 开始的时间。

按 **猝发周期**，使用数字键盘输入时间值 10，在弹出的菜单中选择单位 msec。

6. 选择 Burst 触发源

按 **触发** → **触发源**，选择内部触发。

7. 设置延时

延时仅适用于 N 循环和无限脉冲串类型，是指信号发生器从接受到触发信号到开始输出 N 循环（或无限）脉冲串之间的时间。按 **延时**，使用数字键盘输入所需的时间值 1，在弹出的菜单中选择单位 msec。

8. 启用输出

按 **Output1** 键，背灯变亮，[CH1] 连接器以当前配置输出 Burst 波形。

9. 观察输出波形

使用 BNC 连接线将 DG1000Z 的 [CH1] 连接器与示波器相连接，下图为由示波

器观察到的波形。





图 10 Burst 波形

远程控制

DG1000Z 支持通过 USB、LAN 或 GPIB（选件）接口与计算机进行通信从而实现远程控制。远程控制基于 SCPI 命令集（Standard Commands for Programmable Instruments，用于可编程仪器的标准命令集）实现。本节将介绍如何使用 RIGOL 提供的通用 PC 软件 Ultra Sigma 发送 SCPI 命令并通过 USB 接口对信号发生器进行远程控制。有关命令的详细说明请参考本产品的《编程手册》。

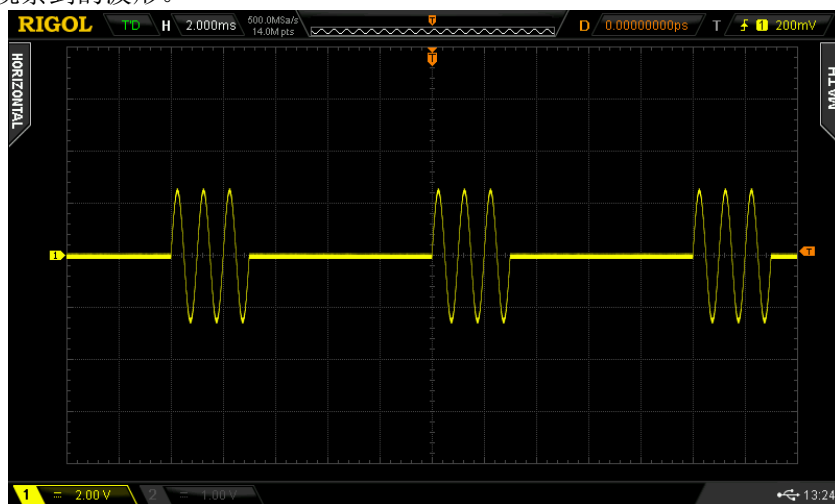
当仪器工作在远程模式时，用户界面显示  图标，前面板按键被锁定（**Help** 除外）。此时，您可以按 **Help** 键退出远程模式。

1. 安装 Ultra Sigma 软件

获取 Ultra Sigma 软件，然后按照指导正确安装软件及所需组件。您可以登录 RIGOL 网站下载最新版本的 Ultra Sigma 软件。

2. 通过 USB 接口远程控制信号发生器

1) 连接设备

使用 USB 数据线连接信号发生器（USB Device）与计算机（USB Host）。

2) 安装 USB 驱动

本信号发生器为 USB-TMC 设备，将信号发生器与 PC 正确连接并且开机后（信号发生器将自动配置为 USB 接口），PC 将弹出硬件更新向导对话框，请按照向导的提示安装 USB Test and Measurement Device (IVI) 驱动程序。

3) 搜索设备资源

打开 Ultra Sigma，软件将自动搜索当前连接到 PC 上的信号发生器资源，您也可以点击 **USB-TMC** 进行搜索。

4) 查看设备资源

搜索到的资源将出现在 RIGOL Online Resource 目录下，并且显示仪器的型号和 USB 接口信息，如图 11 所示：



图 11 查看 USB 仪器资源

5) 通讯测试

右击资源名 DG1062Z

(USB0::0x1AB1::0x0642::DG1ZA000000000::INSTR)，选择 SCPI Panel Control，打开远程命令控制面板，即可通过该面板发送命令和读取数据。





图 12 通过 USB 读写命令

故障处理

下面列举了 DG1000Z 在使用过程中可能出现的故障及排查方法。当您遇到这些故障时，请按照相应的步骤进行处理，如不能处理，请与 **RIGOL** 公司联系，同时请提供您机器的设备信息（获取方法：**Utility** → **系统信息**）。

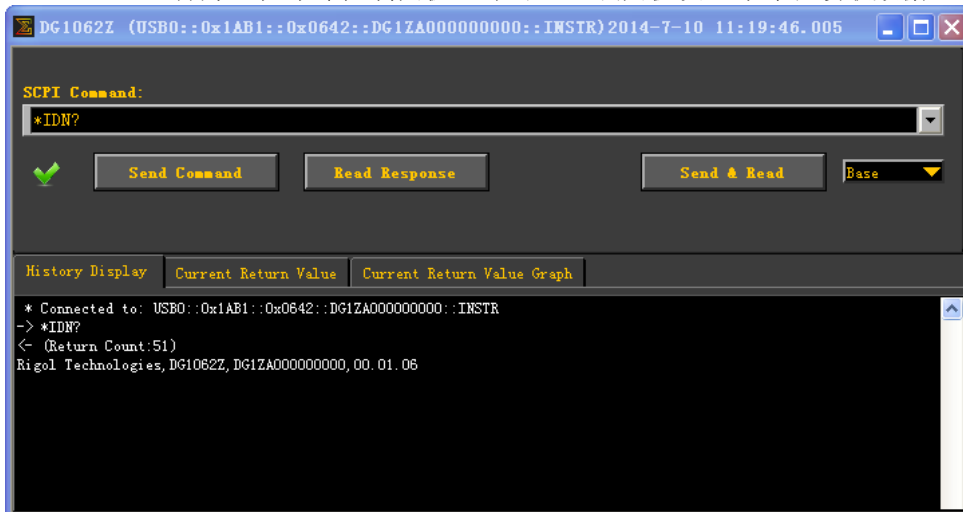
1. 如果按下电源键信号发生器仍然黑屏，没有任何显示：
 - 1) 检查电源接头是否接好。
 - 2) 检查电源键是否按实。
 - 3) 做完上述检查后，重新启动仪器。
 - 4) 如果仍然无法正常使用本产品，请与 **RIGOL** 联系。
2. 屏幕显示太暗，看不清：
 - 1) 检查液晶屏的亮度和对比度设置值是否太小。
 - 2) 按 **Utility** → **系统设置** → **显示设置**，进入屏幕显示设置菜单，然后分别按 **亮度** 和 **对比度** 软键，使用数字键盘或旋钮调节信号发生器液晶屏的亮度和对比度至合适的状态。
3. 信号发生器被锁定：
 - 1) 检查信号发生器是否工作在远程控制模式（远程控制时，用户界面状态栏显示  标志）。按 **Help** 键可退出远程控制模式，解锁前面板。
 - 2) 重新启动信号发生器的电源，也可解除锁定。
4. 设置正确但无波形输出：
 - 1) 检查 BNC 电缆是否与相应的 **[CH1]** 或 **[CH2]** 通道输出端口紧固连接。
 - 2) 检查 BNC 线是否有内部损伤。
 - 3) 检查 BNC 线与测试仪器是否紧固连接。
 - 4) 检查 **Output1** 或 **Output2** 键背灯是否点亮。如果未点亮，按下相应按键使其背灯点亮。
 - 5) 做完上述检查后，将 **Utility** → **系统设置** → **开机设置** 设为上次值，然后重新启动仪器。
 - 6) 如果仍然无法正常使用本产品，请与 **RIGOL** 联系。
5. U 盘设备不能被识别：
 - 1) 检查 U 盘设备是否连接至其他仪器或计算机上可以正常工作。
 - 2) 确认使用的为 FAT32 格式 Flash 型 U 盘设备，本仪器不支持硬盘型 U 盘设备。
 - 3) 重新启动仪器后，再插入 U 盘设备进行检查。
 - 4) 如果仍然无法正常使用 U 盘，请与 **RIGOL** 联系。
6. 如何以 dBm 为单位设置波形的幅度？
 - 1) 按 **CH1|CH2** 键选择所需通道。
 - 2) 检查 **Utility** → **通道设置** → **输出设置** → **阻抗** 是否为高阻。若是，此时

无法以 dBm 为单位设置波形的幅度，请按 **阻抗** 选择负载并使用数字键盘或旋钮设置合适的负载值。

- 3) 选择所需的波形，按 **幅度/高电平** 使“幅度”突出显示，通过数字键盘输入所需的数值，在弹出的菜单中选择单位 dBm 即可。

7. 性能校验测试没有通过：

- (1) 检查信号源是否在校准周期内（校准周期为1年）；
- (2) 确认是否在测试之前将信号源预热了至少30分钟；
- (3) 检查信号源是否处于规定环境温度下；
- (4) 确认测试是否处于强磁环境下进行；
- (5) 检查信号源以及测试系统的供电是否有强干扰；
- (6) 检查使用的测试设备的性能是否符合要求；
- (7) 确保使用的测试设备在校准周期内；
- (8) 检查使用的测试设备是否在其手册要求的工作条件下；
- (9) 检查所有的连接是否紧固；
- (10) 查看所有的线缆是否有内部损伤；
- (11) 确保操作符合性能校验手册要求的设置和流程；
- (12) 确认误差计算是否有失误；
- (13) 正确理解本产品对“典型值”的定义：指产品在特定条件下的性能指标。

更多产品信息

您可以使用菜单 **Utility** → **系统信息** 获取您的设备信息，包括型号、序列号和软件版本号，还可查看所有选件的安装状态。

欲了解本产品更多信息，请查阅相关手册（您可登录**RIGOL**网站（www.rigol.com）下载）。

《DG1000Z用户手册》：提供本产品的功能介绍及操作方法、远程控制方法、在使用过程中可能出现的故障及处理方法、性能指标以及订货信息；

《DG1000Z编程手册》：提供本产品的SCPI命令集以及编程实例；

《DG1000Z数据手册》：提供本产品的主要特色和技术指标。

联系我们

如您在使用此产品或本手册的过程中有任何问题或需求，请与 **RIGOL** 联系：

电子邮箱：service@rigol.com

网址：www.rigol.com

RIGOL

Quick Guide

DG1000Z Series Function/Arbitrary Waveform Generator

**Mar. 2017
RIGOL TECHNOLOGIES, INC.**

Guaranty and Declaration

Copyright

© 2013 **RIGOL** TECHNOLOGIES, INC. All Rights Reserved.

Trademark Information

RIGOL is a registered trademark of **RIGOL** TECHNOLOGIES, INC.

Publication Number

QGB09106-1110

Notices

- **RIGOL** products are covered by P.R.C. and foreign patents, issued and pending.
- **RIGOL** reserves the right to modify or change parts of or all the specifications and pricing policies at the company's sole decision.
- Information in this publication replaces all previously released materials.
- Information in this publication is subject to change without notice.
- **RIGOL** shall not be liable for either incidental or consequential losses in connection with the furnishing, use, or performance of this manual, as well as any information contained.
- Any part of this document is forbidden to be copied, photocopied, or rearranged without prior written approval of **RIGOL**.

Product Certification

RIGOL guarantees that this product conforms to the national and industrial standards in China as well as the ISO9001:2008 standard and the ISO14001:2004 standard. Other international standard conformance certifications are in progress.

Contact Us

If you have any problem or requirement when using our products or this manual, please contact **RIGOL**.

E-mail: service@rigol.com

Website: www.rigol.com

Safety Requirement

General Safety Summary

Please review the following safety precautions carefully before putting the instrument into operation so as to avoid any personal injury or damage to the instrument and any product connected to it. To prevent potential hazards, please follow the instructions specified in this manual to use the instrument properly.

Use Proper Power Cord.

Only the exclusive power cord designed for the instrument and authorized for use within the local country could be used.

Ground the Instrument.

The instrument is grounded through the Protective Earth lead of the power cord. To avoid electric shock, connect the earth terminal of the power cord to the Protective Earth terminal before connecting any input or output terminals.

Connect the Probe Correctly.

If a probe is used, do not connect the ground lead to high voltage since it has isobaric electric potential as the ground.

Observe All Terminal Ratings.

To avoid fire or shock hazard, observe all ratings and markers on the instrument and check your manual for more information about ratings before connecting the instrument.

Use Proper Overvoltage Protection.

Ensure that no overvoltage (such as that caused by a bolt of lightning) can reach the product. Otherwise, the operator might be exposed to the danger of an electric shock.

Do Not Operate Without Covers.

Do not operate the instrument with covers or panels removed.

Do Not Insert Anything Into the Air Outlet.

Do not insert anything into the air outlet to avoid damage to the instrument.

Use Proper Fuse.

Please use the specified fuses.

Avoid Circuit or Wire Exposure.

Do not touch exposed junctions and components when the unit is powered on.

Do Not Operate With Suspected Failures.

If you suspect that any damage may occur to the instrument, have it inspected by **RIGOL** authorized personnel before further operations. Any maintenance, adjustment or replacement especially to circuits or accessories must be performed by **RIGOL**

authorized personnel.

Provide Adequate Ventilation.

Inadequate ventilation may cause an increase of temperature in the instrument, which would cause damage to the instrument. So please keep the instrument well ventilated and inspect the air outlet and the fan regularly.

Do Not Operate in Wet Conditions.

To avoid short circuit inside the instrument or electric shock, never operate the instrument in a humid environment.

Do Not Operate in an Explosive Atmosphere.

To avoid personal injuries or damage to the instrument, never operate the instrument in an explosive atmosphere.

Keep Instrument Surfaces Clean and Dry.

To avoid dust or moisture from affecting the performance of the instrument, keep the surfaces of the instrument clean and dry.

Prevent Electrostatic Impact.

Operate the instrument in an electrostatic discharge protective environment to avoid damage induced by static discharges. Always ground both the internal and external conductors of cables to release static before making connections.

Use the Battery Properly.

Do not expose the battery (if available) to high temperature or fire. Keep it out of the reach of children. Improper change of a battery (lithium battery) may cause an explosion. Use the **RIGOL** specified battery only.

Handle with Caution.

Please handle with care during transportation to avoid damage to keys, knobs, interfaces, and other parts on the panels.

Safety Notices and Symbols

Safety Notices in this Manual:



WARNING

Indicates a potentially hazardous situation or practice which, if not avoided, will result in serious injury or death.



CAUTION

Indicates a potentially hazardous situation or practice which, if not avoided, could result in damage to the product or loss of important data.

Safety Terms on the Product:

DANGER It calls attention to an operation, if not correctly performed, could result in injury or hazard immediately.

WARNING It calls attention to an operation, if not correctly performed, could result in potential injury or hazard.

CAUTION It calls attention to an operation, if not correctly performed, could result in damage to the product or other devices connected to the product.

Safety Symbols on the Product:



Hazardous Voltage



Safety Warning



Protective Earth Terminal



Chassis Ground



Test Ground

Allgemeine Sicherheits Informationen

Überprüfen Sie die folgenden Sicherheitshinweise sorgfältig um Personenschäden oder Schäden am Gerät und an damit verbundenen weiteren Geräten zu vermeiden. Zur Vermeidung von Gefahren, nutzen Sie bitte das Gerät nur so, wie in diesem Handbuch angegeben.

Um Feuer oder Verletzungen zu vermeiden, verwenden Sie ein ordnungsgemäßes Netzkabel.

Verwenden Sie für dieses Gerät nur das für ihr Land zugelassene und genehmigte Netzkabel.

Erden des Gerätes.

Das Gerät ist durch den Schutzleiter im Netzkabel geerdet. Um Gefahren durch elektrischen Schlag zu vermeiden, ist es unerlässlich, die Erdung durchzuführen. Erst dann dürfen weitere Ein- oder Ausgänge verbunden werden.

Anschluss eines Tastkopfes.

Die Erdungsklemmen der Sonden sind auf dem gleichen Spannungspegel des Instruments geerdet. Schließen Sie die Erdungsklemmen an keine hohe Spannung an.

Beachten Sie alle Anschlüsse.

Zur Vermeidung von Feuer oder Stromschlag, beachten Sie alle Bemerkungen und Markierungen auf dem Instrument. Befolgen Sie die Bedienungsanleitung für weitere Informationen, bevor Sie weitere Anschlüsse an das Instrument legen.

Verwenden Sie einen geeigneten Überspannungsschutz.

Stellen Sie sicher, daß keinerlei Überspannung (wie z.B. durch Gewitter verursacht) das Gerät erreichen kann. Andernfalls besteht für den Anwender die Gefahr eines Stromschlages.

Nicht ohne Abdeckung einschalten.

Betreiben Sie das Gerät nicht mit entfernten Gehäuse-Abdeckungen.

Betreiben Sie das Gerät nicht geöffnet.

Der Betrieb mit offenen oder entfernten Gehäuseteilen ist nicht zulässig. Nichts in entsprechende Öffnungen stecken (Lüfter z.B.)

Passende Sicherung verwenden.

Setzen Sie nur die spezifikationsgemäßen Sicherungen ein.

Vermeiden Sie ungeschützte Verbindungen.

Berühren Sie keine unisolierten Verbindungen oder Baugruppen, während das Gerät in Betrieb ist.

Betreiben Sie das Gerät nicht im Fehlerfall.

Wenn Sie am Gerät einen Defekt vermuten, sorgen Sie dafür, bevor Sie das Gerät wieder

betreiben, dass eine Untersuchung durch **RIGOL** autorisiertem Personal durchgeführt wird. Jedwede Wartung, Einstellarbeiten oder Austausch von Teilen am Gerät, sowie am Zubehör dürfen nur von **RIGOL** autorisiertem Personal durchgeführt werden.

Belüftung sicherstellen.

Unzureichende Belüftung kann zu Temperaturanstiegen und somit zu thermischen Schäden am Gerät führen. Stellen Sie deswegen die Belüftung sicher und kontrollieren regelmäßig Lüfter und Belüftungsöffnungen.

Nicht in feuchter Umgebung betreiben.

Zur Vermeidung von Kurzschluß im Geräteinneren und Stromschlag betreiben Sie das Gerät bitte niemals in feuchter Umgebung.

Nicht in explosiver Atmosphäre betreiben.

Zur Vermeidung von Personen- und Sachschäden ist es unumgänglich, das Gerät ausschließlich fernab jedweder explosiven Atmosphäre zu betreiben.

Geräteoberflächen sauber und trocken halten.

Um den Einfluß von Staub und Feuchtigkeit aus der Luft auszuschließen, halten Sie bitte die Geräteoberflächen sauber und trocken.

Schutz gegen elektrostatische Entladung (ESD).

Sorgen Sie für eine elektrostatisch geschützte Umgebung, um somit Schäden und Funktionsstörungen durch ESD zu vermeiden. Erden Sie vor dem Anschluß immer Innen- und Außenleiter der Verbindungsleitung, um statische Aufladung zu entladen.

Die richtige Verwendung des Akku.

Wenn eine Batterie verwendet wird, vermeiden Sie hohe Temperaturen bzw. Feuer ausgesetzt werden. Bewahren Sie es außerhalb der Reichweite von Kindern auf. Unsachgemäße Änderung der Batterie (Anmerkung: Lithium-Batterie) kann zu einer Explosion führen. Verwenden Sie nur von **RIGOL** angegebenen Akkus.

Sicherer Transport.

Transportieren Sie das Gerät sorgfältig (Verpackung!), um Schäden an Bedienelementen, Anschlüssen und anderen Teilen zu vermeiden.

Sicherheits Begriffe und Symbole

Begriffe in diesem Guide:



WARNING

Die Kennzeichnung WARNING beschreibt Gefahrenquellen die leibliche Schäden oder den Tod von Personen zur Folge haben können.



CAUTION

Die Kennzeichnung Caution (Vorsicht) beschreibt Gefahrenquellen die Schäden am Gerät hervorrufen können.

Begriffe auf dem Produkt:

DANGER weist auf eine Verletzung oder Gefährdung hin, die sofort geschehen kann.

WARNING weist auf eine Verletzung oder Gefährdung hin, die möglicherweise nicht sofort geschehen.

CAUTION weist auf eine Verletzung oder Gefährdung hin und bedeutet, dass eine mögliche Beschädigung des Instruments oder anderer Gegenstände auftreten kann.

Symbole auf dem Produkt:



**Gefährliche
Spannung**



**Sicherheits-
Hinweis**



Schutz-erde



Gehäusemasse



Erde

Care and Cleaning

Care

Do not store or leave the instrument where it may be exposed to direct sunlight for long periods of time.

Cleaning

Clean the instrument regularly according to its operating conditions.

1. Disconnect the instrument from all power sources.
2. Clean the external surfaces of the instrument with a soft cloth dampened with mild detergent or water. When cleaning the LCD, take care to avoid scarifying it.



CAUTION

To avoid damage to the instrument, do not expose it to caustic liquids.



WARNING

To avoid short-circuit resulting from moisture or personal injuries, ensure that the instrument is completely dry before connecting it to the power supply.

Environmental Considerations

The following symbol indicates that this product complies with the WEEE Directive 2002/96/EC.



Product End-of-Life Handling

The equipment may contain substances that could be harmful to the environment or human health. To avoid the release of such substances into the environment and avoid harm to human health, we recommend you to recycle this product appropriately to ensure that most materials are reused or recycled properly. Please contact your local authorities for disposal or recycling information.

From: RIGOL Technologies Inc

Date: May 5, 2014

156# Cai He Village, Sha He Town, Chang Ping District, Beijing, China

<http://www.rigol.com>

Declaration of RoHS&WEEE Conformity

RoHS: The European Union of 2011/65/EU Restriction of Hazardous Substances (RoHS) Directive, which applies to all electrical products and their component parts, offered for sale into the European Union after July 22, 2014, restricts the presence of the six substances: Lead (Pb), Cadmium (Cd), Mercury (Hg), Hexavalent Chromium (Cr⁶⁺), Polybrominated biphenylethers (PBBs), and Polybrominated diphenylethers (PBDEs). In view of legal and market requirements, Rigol has restricted use of Pb, Cd, Hg, Cr⁶⁺, PBBs, PBDEs in our products. In addition, we require all our direct suppliers to strictly limit or prohibit use of hazardous substances. All its AVL (Approved Vendors List) components apply for RoHS.

Content of Compliance

Lead	<0.1% by weight (1000 ppm)	Mercury	<0.1% by weight (1000 ppm)
Cadmium	<0.01% by weight (100 ppm)	Hexavalent Chrome (Cr ⁶⁺)	<0.1% by weight (1000 ppm)
PBBs	<0.1% by weight (1000 ppm)	PBDEs	<0.1% by weight (1000 ppm)

WEEE: The European Union of 2012/19/EU, Waste Electrical and Electronic Equipment percentage of reused, recycled and recovered materials, such as metals, plastics, and components of waste electrical and electronic equipment.

We are registered in Germany in the WEEE (in Germany, EAR) register as a manufacturer of category 9 (monitoring and control) equipment and have the assigned registration number

WEEE-Reg.-No. : DE88132002

in our commercial documents.

RIGOL Technologies Inc

Weiming Mao
 Director of Central Quality and
 Environmental Management



Document Overview

Format Conventions in this Manual

1. **Button:**
The key at the front panel is denoted by the format of "Text Box + Button Name (Bold)" in the manual, for example, **Sine**.
2. **Menu:**
The menu is denoted by the format of "Character Shading + Menu Word (Bold)" in the manual, for example, **Freq**.
3. **Connector:**
The connector at the front or rear panel is denoted by the format of "Square Brackets + Connector Name (Bold) in the manual, for example, **[Counter]**.
4. **Operation Steps:**
The next step of the operation is denoted by an arrow "→" in the manual. For example, **Sine** → **Freq** denotes pressing **Sine** at the front panel and then pressing **Freq**.

Content Conventions in this Manual

1. DG1000Z series function/arbitrary waveform generator includes DG1022Z, DG1032Z and DG1062Z. In this manual, DG1062Z is taken as an example to illustrate the basic operations of the generator. For more details, please refer to DG1000Z Series Function/Arbitrary Waveform Generator User's Guide.

Model	Channels	Max. Frequency
DG1062Z	2	60MHz
DG1032Z	2	30MHz
DG1022Z	2	25MHz

2. All models of DG1000Z series function/arbitrary waveform generator are equipped with dual channels (CH1 and CH2). Unless otherwise specified, this manual takes CH1 as an example to introduce the operation method which is also applied to CH2.

Manuals of this Product

The manuals of this product mainly include the quick guide, user's guide, programming guide and data sheet. For the newest version of the desired manual, download it from www.rigol.com.

Content

Guaranty and Declaration	I
Safety Requirement.....	II
General Safety Summary	II
Safety Notices and Symbols	IV
Allgemeine Sicherheits Informationen	V
Sicherheits Begriffe und Symbole	VII
Care and Cleaning	VIII
Environmental Considerations	VIII
Document Overview	X
Quick Start.....	1
General Inspection	1
To Adjust the Handle	2
Appearance and Dimensions	3
Front Panel Overview.....	4
Rear Panel Overview.....	9
Power On and Inspection	11
To Connect to Power	11
Power-on Inspection.....	11
To Set the System Language.....	11
User Interface	12
Dual Channels Parameters Mode	12
Dual Channels Graph Mode	14
Single Channel Mode	14
To Use the Built-in Help System.....	15
Basic Operations.....	16
To Output Basic Waveform	16
To Output Arbitrary Waveform.....	17
To Output Harmonics	19
To Output AM Modulated Waveform	21
To Output FSK Modulated Waveform	22
To Output Sweep Waveform.....	23
To Output Burst Waveform.....	24
Remote Control	26
Troubleshooting	28
For More Product Information.....	30
Contact Us	30

Quick Start

General Inspection

1. **Inspect the packaging**

If the packaging has been damaged, do not dispose the damaged packaging or cushioning materials until the shipment has been checked for completeness and has passed both electrical and mechanical tests.

The consigner or carrier shall be liable for the damage to the instrument resulting from shipment. **RIGOL** would not be responsible for free maintenance/rework or replacement of the instrument.

2. **Inspect the instrument**

In case of any mechanical damage, missing parts, or failure in passing the electrical and mechanical tests, contact your **RIGOL** sales representative.

3. **Check the accessories**

Please check the accessories according to the packing lists. If the accessories are damaged or incomplete, please contact your **RIGOL** sales representative.

To Adjust the Handle

To adjust the handle position of the instrument, please grip the handle by sides and pull it outward. Then, rotate the handle to the desired position. The operating method is shown below.

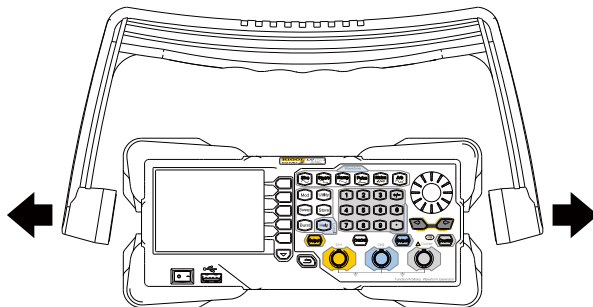

Adjusting the handle

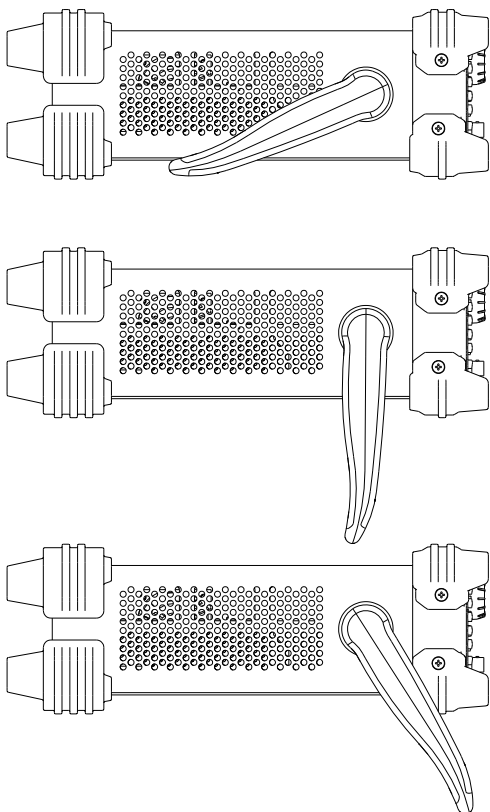

Viewing Positions

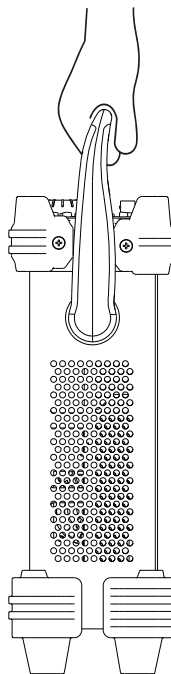

Carrying Position

Appearance and Dimensions

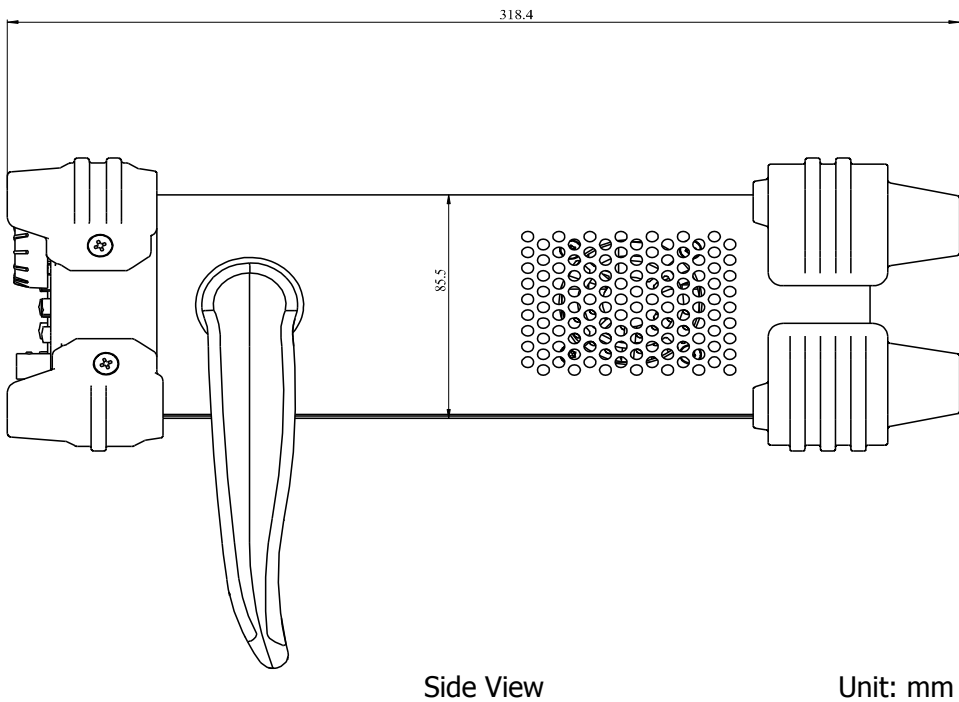
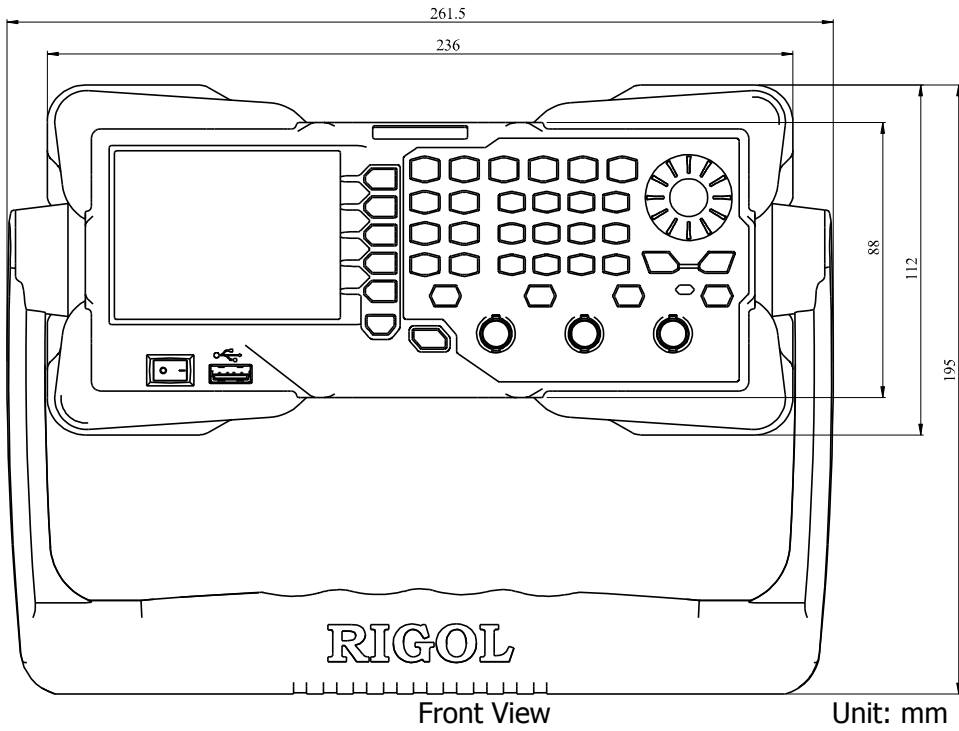

Front Panel Overview

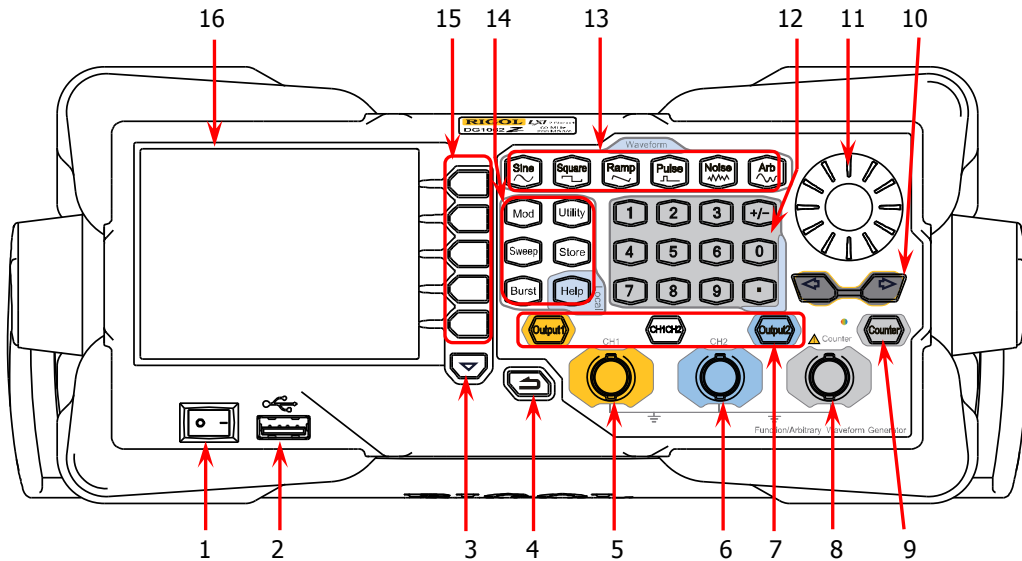

Figure 1 Front Panel

1. Power Key

The power key is used to turn the generator on or off.

2. USB Host

Support FAT32 format Flash type USB storage device, **RIGOL** TMC digital oscilloscope (DS), power amplifier (PA) (Option) and USB to GPIB interface converter (Option).

- USB storage device: read the waveform or state files saved in the USB storage device or store the current instrument states or edited waveform data into the USB storage device. In addition, the content displayed on the screen also can be saved as a picture file (*.Bmp) into the USB storage device.
- TMC DS: seamlessly interconnect with the **RIGOL** DS that meets the TMC standard. Read and store the waveform data collected by the DS and rebuilt waveform lossless.
- PA (Option): support the **RIGOL** power amplifier (such as PA1011). You can configure it online and the signal is outputted after whose power is amplified.
- USB to GPIB interface converter (Option): expand the GPIB interface for **RIGOL** instrument with USB Host interface but without GPIB interface.

3. Page Down

This key is used to open the next page of the current menu.

4. Return to the Previous Menu

Quit the current menu and return to the previous menu.

5. CH1 Output Connector

BNC connector. The nominal output impedance is 50Ω.

When the **Output1** is enabled (the backlight goes on), this connector outputs the waveform based on the current settings of CH1.

6. CH2 Output Connector

BNC connector. The nominal output impedance is 50Ω.

When the **Output2** is enabled (the backlight goes on), this connector outputs the waveform based on the current settings of CH2.

7. Channel Control Area



Used to control the output of CH1.

- Press this key to open the output of CH1, the backlight goes on and the **[CH1]** connector outputs the waveform based on the current settings of CH1.
- Press this key again to close the output of CH1 and the backlight goes off.



Used to control the output of CH2.

- Press this key to open the output of CH2, the backlight goes on and the **[CH2]** connector outputs the waveform based on the current settings of CH2.
- Press this key again to close the output of CH2 and the backlight goes off.

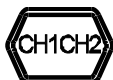

Used to switch the current selected channel between CH1 and CH2.



CAUTION

Overvoltage protection of CH1 and CH2 will take effect once any of the following conditions is met. When overvoltage protection takes effect, a message will be displayed and the output is disabled.

- The input voltage is higher than $\pm 11.5 \times (1 \pm 5\%) \text{V}$ ($< 10 \text{kHz}$) when the amplitude of the generator is greater than 2Vpp or the DC offset is greater than $|2V_{\text{DC}}|$.
- The input voltage is higher than $\pm 3.5 \times (1 \pm 5\%) \text{V}$ ($< 10 \text{kHz}$) when the amplitude of the generator is lower than or equal to 2Vpp or the DC offset is lower than or equal to $|2V_{\text{DC}}|$.

8. Input Connector for the Signal Measured by Counter

BNC connector. The input impedance is 1MΩ. This connector is used to accept the signal measured by the counter.

**Note**

To avoid damage to the instrument, the input signal voltage cannot exceed $\pm 7V_{ac+dc}$.

9. Counter

Used to turn the counter on or off.

- Press this key to turn the counter on, the backlight goes on and the indicator at the left of **Counter** blinks.
- Press this key again to turn the counter off and the backlight goes off.

Note: the sync signal of CH2 will be disabled if the counter is turned on and it will be enabled after the counter is turned off.

10. Direction Keys

- Used to move the cursor to select the digit to be edited when setting parameter using knob.
- Used to delete the number at the left of the cursor when inputting parameter using numeric keyboard.
- Used to unfold or fold the selected directory when storing or reading file.
- Used to move the cursor to select the desired character in filename input area when editing filename.

11. Knob

- Used to increase (clockwise) or decrease (counterclockwise) the value marked by the cursor when setting parameter using knob.
- Used to select the storage location when storing a file or used to select the file to be read when reading file.
- Used to select a character from the virtual keyboard when editing filename.
- Used to select a desired built-in arbitrary waveform from **Arb** → **Select Wform** → **BuiltIn**.

12. Numeric Keyboard

The numeric keyboard consists of number keys (0 to 9), decimal point (.) and sign key (+/-) and is used to set the parameters.

Note:

- The sign key is used to switch between uppercase and lowercase inputs.
- Press the decimal point twice to save the content displayed in the user interface in the USB storage device in *.Bmp format.

13. Waveform Keys

Output Sine with frequency from 1 μ Hz to 60MHz.

- The backlight goes on when this function is selected.
- You can set the parameters for sine waveform including Freq/Period, Ampl/HiLevel, Offset/LoLevel and Start Phase.



Output Square with frequency from 1 μ Hz to 25MHz and variable duty cycle.

- The backlight goes on when this function is selected.
- You can set the parameters for square waveform including Freq/Period, Ampl/HiLevel, Offset/LoLevel, Duty Cycle and Start Phase.



Output Ramp with frequency from 1 μ Hz to 1MHz and variable symmetry.

- The backlight goes on when this function is selected.
- You can set the parameters for ramp waveform including Freq/Period, Ampl/HiLevel, Offset/LoLevel, Symmetry and Start Phase.



Output Pulse with frequency from 1 μ Hz to 25MHz and variable pulse width and edge times.

- The backlight goes on when this function is selected.
- You can set the parameters for pulse including Freq/Period, Ampl/HiLevel, Offset/LoLevel, Width/Duty, Leading, Trailing and Start Phase.



Output Gaussian Noise with 60MHz bandwidth.

- The backlight goes on when this function is selected.
- You can set the parameters for Noise including Ampl/HiLevel and Offset/LoLevel.



Output Arbitrary waveform with frequency from 1 μ Hz to 20MHz.

- Support two output modes:
Sample Rate and **Frequency**.
- Up to 160 built-in waveforms.
- The backlight goes on when this function is selected.
- You can set the parameters for Arb waveform including Freq/Period, Ampl/HiLevel, Offset/LoLevel and Start Phase.

14. Function Keys



Output multiple types of modulated waveforms.

- Support multiple modulation types: AM, FM, PM, ASK, FSK, PSK and PWM.
- Support internal and external modulation sources.
- The backlight goes on when this function is selected.



Output Sweep waveform for Sine, Square, Ramp and Arb (except DC).

- 3 Sweep types: Linear, Log and Step.
- 3 types of trigger sources: Internal, External and Manual.
- Provide frequency mark function used to control the status of the sync signal.

- The backlight goes on when this function is selected.



Output Burst waveform for Sine, Square, Ramp, Pulse and Arb (except DC).

- 3 Burst types: NCycle, Infinite and Gated.
- Noise can also be used to generate gated burst waveform.
- 3 types of trigger sources: Internal, External and Manual.
- The backlight goes on when this function is selected.



Used to set the auxiliary function parameters and system parameters. The backlight goes on when this function is selected.



Store or recall the instrument state or the user-defined arbitrary waveform data.

- A nonvolatile memory (C disk) is built in and an USB storage device (D disk) can be connected.
- The backlight goes on when this function is selected.



To get the help information of any front panel key or menu softkey, press this key and then press the desired key.

Note:

- 1) When the instrument is working in remote mode, press this key to return to local mode.
- 2) Used to lock or unlock the keyboard. Press and hold **Help** to lock the front panel keys and at this point, the front panel keys (except **Help**) are not available. Press and hold this key again to unlock.

15. Menu Softkeys

Correspond to the menus at the left and pressing the softkey will activate the corresponding menu.

16. LCD

3.5 inches TFT (320×240) color LCD display. The current settings and state of the instrument can be clearly displayed. For detailed information, refer to “**User Interface**”.

Rear Panel Overview

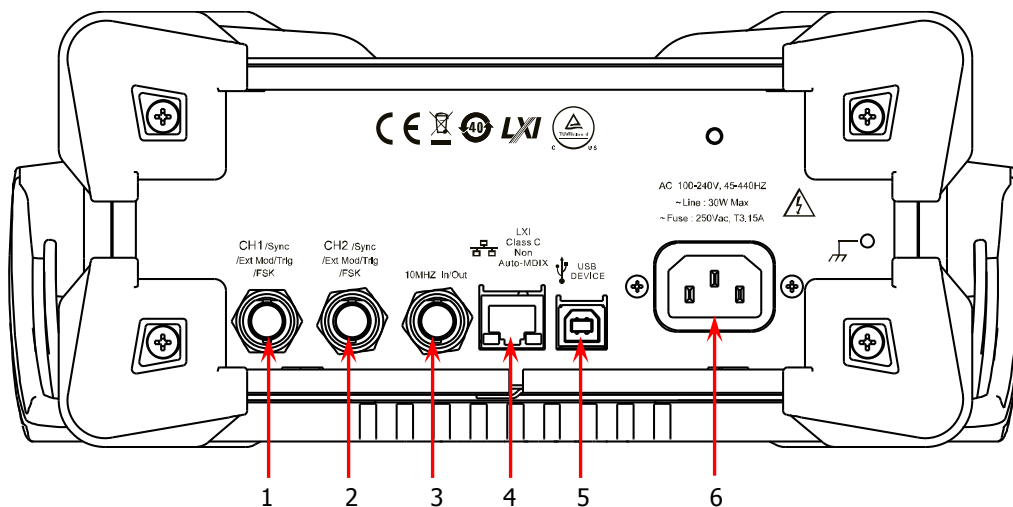

Figure 2 Rear Panel

1. [CH1/Sync/Ext Mod/Trig/FSK]

It is a BNC (female) connector which nominal impedance is 50Ω. The function of this connector is determined by the work mode of CH1.

- **Sync:** when the output of CH1 is enabled, this connector output the corresponding sync signal.
- **Ext Mod:** when AM, FM, PM or PWM of CH1 is enabled and external modulation source is selected, this connector accepts an external modulation signal.
- **FSK:** when ASK, FSK or PSK of CH1 is enabled and external modulation source is selected, this connector accepts an external modulation signal which polarity can be set by users.
- **Trig In:** when Sweep or Burst of CH1 is enabled and external trigger source is selected, this connector accepts an external trigger signal which polarity can be set by users.
- **Trig Out:** when Sweep or Burst of CH1 is enabled and internal or manual trigger source is selected, this connector outputs the trigger signal with specified edge type.

For more detailed information about the signals mentioned above, please refer to the User's Guide.

2. [CH2/Sync/Ext Mod/Trig/FSK]

It is a BNC (female) connector which nominal impedance is 50Ω. The function of this connector is determined by the work mode of CH2.

- **Sync:** when the output of CH2 is enabled, this connector output the corresponding sync signal.
- **Ext Mod:** when AM, FM, PM or PWM of CH2 is enabled and external

modulation source is selected, this connector accepts an external modulation signal.

- **FSK:** when ASK, FSK or PSK of CH2 is enabled and external modulation source is selected, this connector accepts an external modulation signal which polarity can be set by users.
- **Trig In:** when Sweep or Burst of CH2 is enabled and external trigger source is selected, this connector accepts an external trigger signal which polarity can be set by users.
- **Trig Out:** when Sweep or Burst of CH2 is enabled and internal or manual trigger source is selected, this connector outputs the trigger signal with specified edge type.

For more detailed information about the signals mentioned above, please refer to the User's Guide.

3. [10MHz In/Out]

It is a BNC (female) connector which nominal impedance is 50Ω. The function of this connector is determined by the type of the clock source.

- When internal clock source is selected, this connector (used as 10MHz Out) outputs the 10MHz clock signal generated by the internal crystal oscillator inside the generator.
- When external clock source is selected, this connector (used as 10MHz In) accepts an external 10MHz clock signal.

This connector is typically used to synchronize multiple generators. For more detailed information about the signals mentioned above, please refer to the User's Guide.

4. LAN Interface

Through this interface, the generator can be connected to your computer or the network of your computer for remote control. An integrated testing system may be built, as the generator conforms to the LXI Core 2011 Device class standard of LAN-based instrument control.

5. USB Device Interface

This interface is used to connect a computer which can control the generator remotely using PC software or by programming. It is also connected to a PictBridge printer to print the content displayed in the screen.

6. AC Power Socket

The AC power supply specification of this signal generator is 100-240V, 45-440Hz. The maximum input power of the instrument cannot exceed 30W. The specification of the fuse is 250V, T3.15A.

Power On and Inspection

To Connect to Power

Please connect the generator to AC power supply using the power cord supplied in the accessories as shown in the figure below. The AC power supply specification of this generator is 100-240V, 45-440Hz. The maximum input power of the instrument cannot exceed 30W. When the signal generator is connected to AC power supply via this connector, the instrument select the correct voltage range automatically and users do not need to select the voltage range manually.

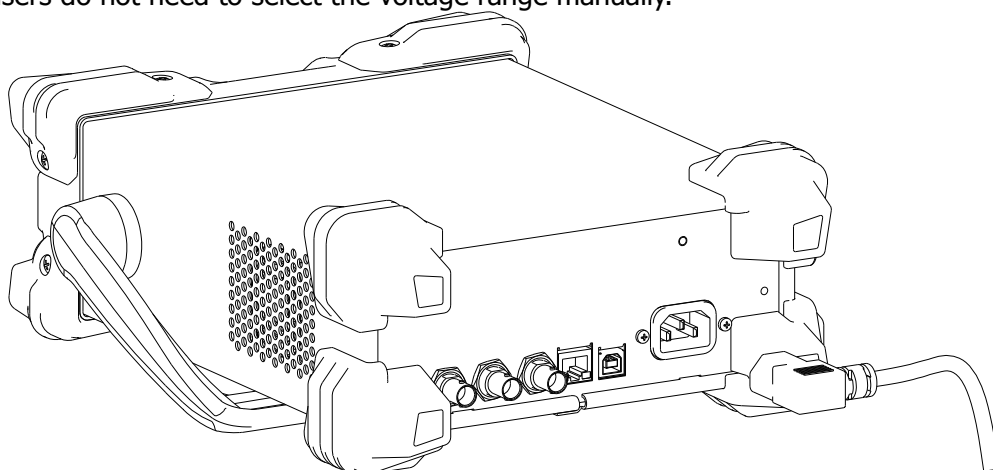



Figure 3 Connect to Power



CAUTION

To avoid electric shock, make sure that the instrument is correctly grounded.

Power-on Inspection

After the power supply is correctly connected, press the power key  at the front panel to turn on the generator. During the start-up, the instrument performs initialization and self-test. After that, the instrument enters the default interface. If the instrument does not start normally, please refer to the "**Troubleshooting**".

To Set the System Language

DG1000Z series function/arbitrary generator supports multiple language menus. You can press **Utility** → **Language** to switch the desired language.

User Interface

The user interface of DG1000Z provides three types of display modes: **Dual Channels Parameters** (default), **Dual Channels Graph** and **Single Channel**. This manual mainly introduces the user interface taking the first display mode as an example.

Dual Channels Parameters Mode

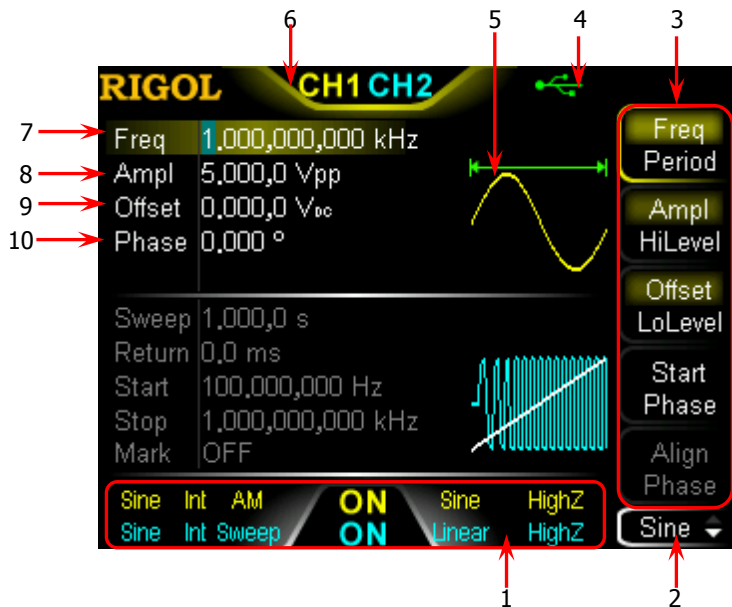

Figure 4 User Interface (Dual Channels Parameters Mode)

1. Channel Output Configuration Status Bar

Display the output configurations of the two channels.

Work Mode:
AM/FM/PM/ASK/FSK/PSK/
PWM/Sweep/Burst

Modulation Waveform of Analog Modulation:
Sine/Square/Tria/UpRamp/DnRamp/Noise/Arb
Polarity of Digital Modulation: Pos/Neg
Type of Sweep: Linear/Log/Step
Type of Burst: Ncycle/Infinite/Gated

Selected Waveform:
Sine
Squ
Ramp
Pulse
Noise
Arb
Harm

Type of Modulation Source: Int/Ext
Type of Sweep/Burst Trig Source: Int/Ext/Mu
Waveform Summing: Sum

Channel Output State:
ON/OFF

Type of Output Impedance:
High Impedance: display HighZ
Load: display impedance value (the default is 50Ω and the range is 1Ω to 10kΩ)



2. Current Function and Page Up/Down Indicator

Display the function name selected currently. For example, "Sine" is displayed when the sine is selected and "Edit" is displayed when the arbitrary waveform editing function is selected. Besides, the up and down arrows at the right of the function name are used to indicate whether page up/down is permitted now.

3. Menu

Display the operation menu of the function selected currently.

4. Status Bar

: displayed when the instrument is connected into LAN correctly.

: displayed when the instrument is in remote mode.

: displayed when the front panel of the instrument is locked.

: displayed when a USB storage device is detected.

: displayed when the instrument is connected with power amplifier correctly.

5. Waveform

Displayed the waveform currently selected by each channel.

6. Channel Status Bar

Used to indicating the selected status and on/off status of the channels. When CH1 is selected, the border of the bar is displayed in yellow. When CH2 is selected, the border of the bar is displayed in blue. When the output of CH1 is enabled, the "CH1" in the bar is highlighted in yellow. When the output of CH2 is enabled, the "CH2" in the bar is highlighted in blue.

Note: you can enable the outputs of the two channels but you cannot select the two channels at the same time.

7. Frequency

Display the waveform frequency of the channel. Press **Freq/Period** to highlight "Freq" and use the numeric keyboard or direction keys and knob to modify this parameter.

8. Amplitude

Display the waveform amplitude of the channel. Press **Ampl/HiLevel** to highlight "Ampl" and use the numeric keyboard or direction keys and knob to modify this parameter.

9. Offset

Display the waveform DC offset of the channel. Press **Offset/LoLevel** to highlight "Offset" and use the numeric keyboard or direction keys and knob to modify this parameter.

10. Phase

Display the waveform start phase of the channel. Press **Start Phase** and use the numeric keyboard or direction keys and knob to modify this parameter.

Dual Channels Graph Mode

Press **Utility** → **System** → **Display** → **DispMode** to select "Dual Graph", as shown in the figure below.

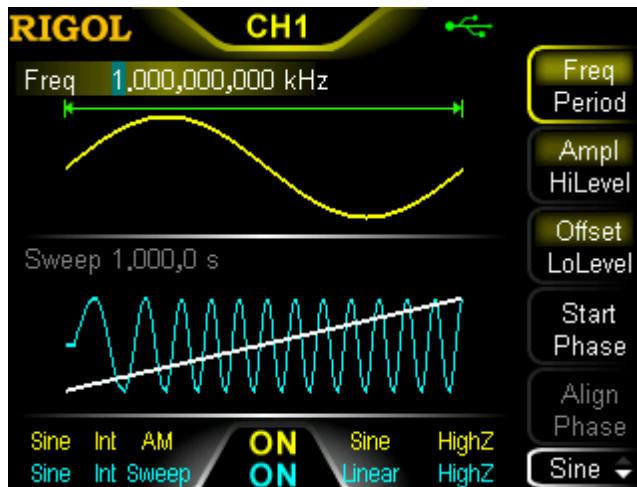

Figure 5 User Interface (Dual Channels Graph Mode)

Single Channel Mode

Press **Utility** → **System** → **Display** → **DispMode** to select "Single View", as shown in the figure below.

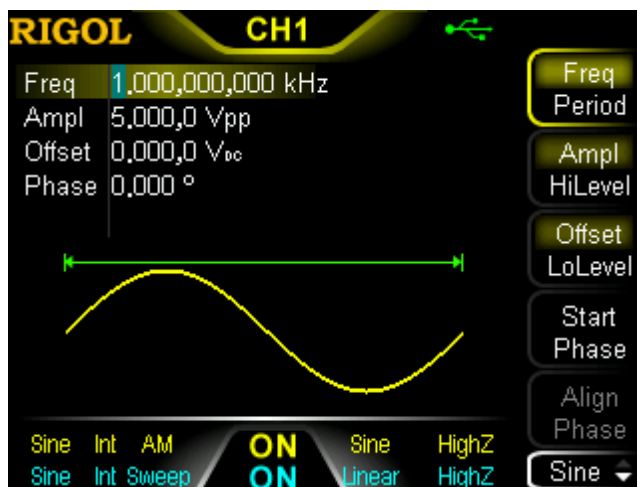

Figure 6 User Interface (Single Channel Mode)





To Use the Built-in Help System

The built-in help system of DG1000Z provides help information for each key and menu softkey at the front panel. Users can view the help of any key when operating the instrument.

1. Acquire the built-in help

Press **Help** and the backlight goes on. Then press the desired key or menu softkey and the corresponding help information is displayed.





2. Page up/down

When the help information is displayed on multiple pages, users can acquire the help information on the previous or next page using  (the previous line)/ (the next line)/ (page up)/ (page down) or the knob.

3. Turn off the current help information

When the help information is displayed in the interface, pressing  at the front panel will turn off the help information currently displayed.

4. Main Help Topics

Press **Help** twice to open the list of main help topics. Use /// or the knob to select the desired help topic and press **Select** to view the corresponding help information.

Basic Operations

To Output Basic Waveform

DG1000Z can output basic waveforms (Sine, Square, Ramp, Pulse and Noise) from one of the channels separately or from the two channels at the same time. This section introduces how to output a sine waveform (Frequency: 20kHz, Amplitude: 2.5Vpp, DC Offset: 500mV_{DC}, Start Phase: 90°) from the [CH1] connector.

1. To select output channel

Press **CH1 | CH2** to select CH1. Now the border of the channel status bar is displayed in yellow.

2. To select the Sine

Press **Sine** to select the sine waveform. The backlight goes on and the corresponding menu is displayed in the right of the screen.

3. To set the frequency/period

Press **Freq/Period** to highlight "Freq", and then use the numeric keyboard to input 20. Then select kHz from the pop-up menu.

- The frequency ranges from 1μHz to 60MHz.
- The frequency units available are MHz, kHz, Hz, mHz and μHz.
- Press this softkey again to switch to period setting.
- The period units available are sec, msec, μsec and nsec.

4. To set the amplitude

Press **Ampl/HiLevel** to highlight "Ampl", and use the numeric keyboard to input 2.5. Then, select Vpp from the pop-up menu.

- The amplitude range is limited by the impedance and frequency/period.
- The amplitude units available are Vpp, mVpp, Vrms, mVrms and dBm (dBm is only valid when the setting in **Utility** → **Channel Set** → **Output Set** → **Imped** is not HighZ).
- Press this softkey again to switch to high level setting.
- The high level units available are V and mV.

5. To set the offset

Press **Offset/LoLevel** to highlight "Offset", and then use the numeric keyboard to input 500. Then, select mV_{DC} from the pop-up menu.

- The range of the offset is limited by the impedance and frequency/period.
- The DC offset voltage units available are V_{DC} and mV_{DC}.
- Press this softkey again to switch to low level setting. The low level must be lower than the high level at least 1mV (when the output impedance is 50Ω).
- The low level units available are V and mV.

6. To set the start phase

Press **Start Phase**, and then use the numeric keyboard to input 90. Then, select ° from the pop-up menu. The start phase ranges from 0° to 360°.

7. To enable the output

Press **Output1** to turn CH1 output on. At this point, the backlight goes on and the **[CH1]** connector outputs waveform with the specified parameters.

8. To observe the output waveform

Connect the **[CH1]** connector to the oscilloscope using BNC cable. The waveform is as shown in the figure below.

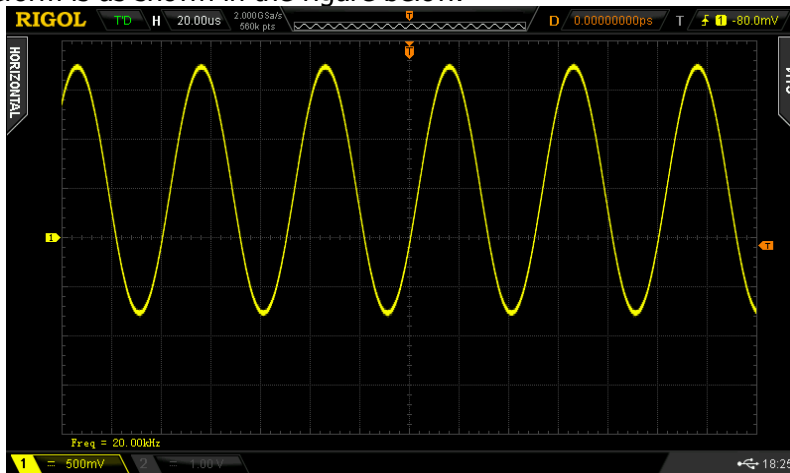

Figure 7 Sine

To Output Arbitrary Waveform

DG1000Z can output the built-in or user-defined arbitrary waveforms from a single channel or from two channels at the same time. This section introduces how to output an arbitrary waveform from the **[CH1]** connector (Edit Points, Sample Rate editing mode, HiLevel: 4V, LoLevel: -2V, Points: 8, Voltage of Point#1 to Point#4: 4V; Voltage of Point#5 to Point#8: -2V).

1. To select output channel

Press **CH1|CH2** to select CH1. Now the border of the channel status bar is displayed in yellow.

2. To enable arbitrary waveform

Press **Arb** to enter the arbitrary waveform setting interface. Please set the frequency, amplitude, offset and start phase of the arbitrary waveform according to "To Output Basic Waveform".

3. To edit arbitrary waveform

Press **Arb** → **Edit Wform** to open the arbitrary waveform editing menu.

- 1) Press **Mode** to select "Sample Rate".
- 2) Press **HiLevel**, use the numeric keyboard to input 4 and select V from the pop-up menu.
- 3) Press **LoLevel**, use the numeric keyboard to input -2 and select V from the pop-up menu.
- 4) Press **Points**, use the numeric keyboard to input 8 and press **Sure**. At this point, a -2V level line appears.
- 5) Press **Edit Points** to enter the points editing interface.
 - Press **Edit Points** to define the first point. Press **Voltage**, use the numeric keyboard to input 4 and select V from the pop-up menu.
 - Press **Edit Points** again, use the numeric keyboard or knob to select point 2; then press **Voltage** to input 4V.
 - Define the voltage of point 3 to point 8 according to the method mentioned above.

4. To select waveform

Press **Arb** → **Select Wform** → **Volatile Wform** to select the waveform edited.

5. To enable the output

Press **Output1** to turn CH1 output on. At this point, the backlight goes on and the **[CH1]** connector outputs arbitrary waveform with the specified parameters.

6. To observe the output waveform

Connect the **[CH1]** connector to the oscilloscope using BNC cable. Now, you can observe the waveform via the oscilloscope.

To Output Harmonics

DG1000Z can be used as a harmonic generator to output harmonic with specified order, amplitude and phase. This section introduces how to output the 2nd and 4th harmonics from the [CH1] connector (Harmonic Amplitude: 2Vpp and 1Vpp, Phase: 30° and 50°, Order: 5).

1. To select output channel

Press **CH1 | CH2** to select CH1. Now the border of the channel status bar is displayed in yellow.

2. To set the parameters of the fundamental waveform

Set the frequency/period, amplitude/high level, offset/low level and start phase of the fundamental waveform according to "To Output Basic Waveform".

3. To enable the harmonic function

Press **Sine** → **Harm** to select "On". Press **Harmonic Para** to enter the harmonic setting menu.

4. To set harmonic order

Press **Order** in the harmonic setting menu, use the numeric keyboard to input 5 and press **Sure**.

- The range is limited by the maximum output frequency of the instrument as well as the fundamental waveform frequency.
- Range: integers within **2** to **maximum output frequency of the instrument ÷ fundamental waveform frequency**. The maximum is 8.

5. To select harmonic type

Press **Type** in the harmonic setting menu to select Even or User.

Method 1: Even

Press this key and the instrument would output fundamental waveform and even harmonics (the 2nd and 4th harmonics).

Method 2: User

Press this key and the instrument would output the user-defined orders of harmonics. The highest order is 8.

8 bits binary data is used to represent the output status of the 8 orders of harmonics respectively, wherein, 1 represents enabling the output of the corresponding harmonic and 0 represents disabling the output of the corresponding harmonic. Users only need to use the numeric keyboard to modify the value of each data bit (note: the leftmost bit representing fundamental waveform is always X and cannot be modified). For example, set the 8 bits data to X101 0000, thus 2nd and 4th orders of harmonics are output.

Note: the actual harmonics output is determined by the "Order" and "Type" currently specified.

6. To set harmonic amplitude

Press **Harmonic Ampl** in the harmonic setting menu to set the amplitude of the 2nd and 4th harmonics.

- 1) Press **SN**, use the numeric keyboard to input 2 and press **Sure**.
- 2) Press **Harmonic Ampl**, use the numeric keyboard to input 2 and select Vpp from the pop-up menu.
- 3) Set the amplitude of the 4th harmonic to 1Vpp according to 1) and 2).

7. To set harmonic phase

Press **Harmonic Phase** in the harmonic setting menu to set the phase of the 2nd and 4th harmonics.

- 1) Press **SN**, use the numeric keyboard to input 2 and press **Sure**.
- 2) Press **Harmonic Phase**, use the numeric keyboard to input 30 and select ° from the pop-up menu.
- 3) Set the phase of the 4th harmonic to 50° according to 1) and 2).

8. To enable the output

Press **Output1** to turn CH1 output on. At this point, the backlight goes on and the **[CH1]** connector outputs the fundamental waveform as well as the 2nd and 4th harmonics.

9. To observe the output waveform

Connect the **[CH1]** connector to the oscilloscope using BNC cable. The waveform is as shown in Figure 8.

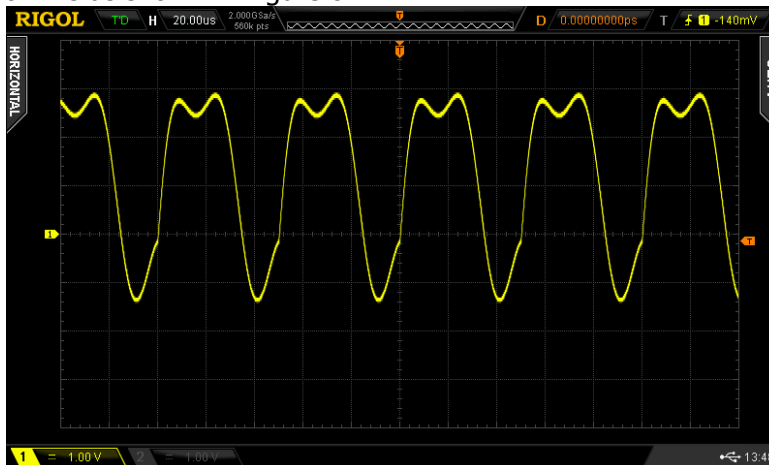

Figure 8 Harmonics

To Output AM Modulated Waveform

For amplitude modulation (AM), the amplitude of the carrier waveform varies with the instantaneous voltage of the modulating waveform. This section introduces how to output AM modulated waveform from the **[CH1]** connector (the carrier is sine with 5kHz frequency and 5Vpp amplitude, the modulating waveform is sine with 200Hz frequency and the modulation depth is 80%).

1. To select output channel

Press **CH1|CH2** to select CH1. Now the border of the channel status bar is displayed in yellow.

2. To set the carrier waveform shape, frequency and amplitude

- 1) Carrier Waveform Shape: press **Sine** to select sine as the carrier waveform.
- 2) Carrier Frequency: press **Freq/Period** to highlight "Freq". At this point, use the numeric keyboard to input 5. Then, select kHz from the pop-up menu.
- 3) Carrier Amplitude: press **Ampl/HiLevel** to highlight "Ampl", and then use the numeric keyboard to input 5. Then, select Vpp from the pop-up menu.

3. To select AM modulation

Press **Mod** → **Type** → **AM** to enable AM function.

- When **Mod** is enabled, **Sweep** or **Burst** will be disabled automatically (if enabled currently).
- **Int** and **AM** will be displayed in the bottom of the screen.

4. To set Modulating waveform frequency

Press **AM Freq**, and then use the numeric keyboard to input 200. Then, select Hz from the pop-up menu.

5. To select modulating waveform

Press **Shape** to select Sine from the pop-up menu.

6. To set modulation depth

Press **AM Depth**, and then use the numeric keyboard to input 80. Then, select % from the pop-up menu.

7. To enable the output

Press **Output1** to turn CH1 output on. At this point, the backlight goes on and the **[CH1]** connector outputs the AM modulated waveform based on the current settings.

8. To observe the output waveform

Connect the **[CH1]** connector to the oscilloscope using BNC cable. The waveform is as shown in the figure below.

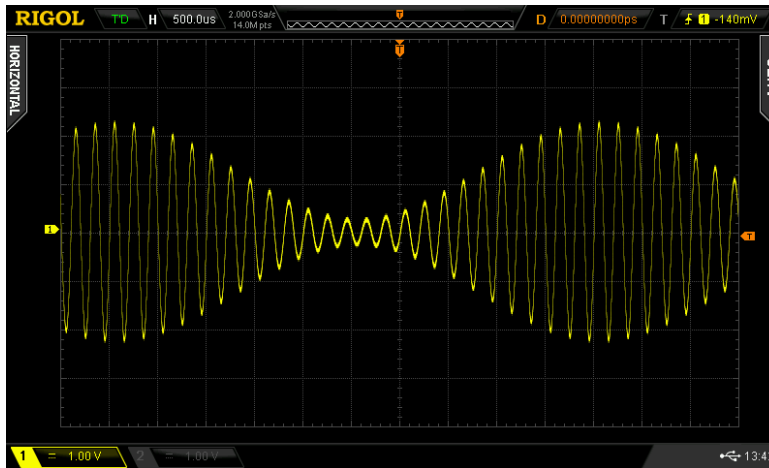

Figure 9 AM Modulated Waveform

To Output FSK Modulated Waveform

For FSK (Frequency Shift Keying) modulation, the generator “shifts” its output frequency between two preset frequencies (carrier frequency and hop frequency). This section introduces how to output FSK modulated waveform from the **[CH1]** connector (the carrier is sine with 3kHz frequency and 5Vpp amplitude, the hop frequency is 500Hz, the FSK rate is 100Hz and the modulating polarity is Pos).

1. To select output channel

Press **CH1 | CH2** to select CH1. Now the boarder of the channel status bar is displayed in yellow.

2. To set the carrier waveform shape, frequency and amplitude

- 1) Carrier Waveform Shape: press **Sine** to select sine as the carrier waveform.
- 2) Carrier Frequency: press **Freq/Period** to highlight “Freq”. At this point, use the numeric keyboard to input 3. Then, select kHz from the pop-up menu.
- 3) Carrier Amplitude: press **Ampl/HiLevel** to highlight “Ampl”, and then use the numeric keyboard to input 5. Then, select Vpp from the pop-up menu.

3. To select FSK modulation

Press **Mod** → **Type** → **FSK** to enable FSK function.

- When **Mod** is enabled, **Sweep** or **Burst** will be automatically disabled (if enabled currently).
- **Int** and **FSK** will be displayed in the bottom of the screen.

4. To set hop frequency

Press **Hop Freq**, use the numeric keyboard to input 500 and select Hz from the pop-up menu.

5. To set FSK rate

Press **FSK Rate**, use the numeric keyboard to input 100 and select Hz from the pop-up menu.

6. To set modulating polarity

Press **Polarity** to select the Pos polarity of the modulating waveform to control the output frequency. At this point, the generator would output the carrier frequency when the modulating waveform is logic low and output the hop frequency when the modulating waveform is logic high.

7. To enable the output

Press **Output1** to turn CH1 output on. At this point, the backlight goes on and the **[CH1]** connector outputs the FSK modulated waveform based on the current settings.

8. To observe the output waveform

Connect the **[CH1]** connector to the oscilloscope using BNC cable. Now, you can observe the waveform via the oscilloscope.

To Output Sweep Waveform

DG1000Z can output sweep waveform from a single channel or from dual channels at the same time. This section introduces how to output sweep waveform from the **[CH1]** connector (Linear sweep type, the carrier is sine with 5Vpp amplitude, the frequency range is 50Hz~1kHz, Sweep Time: 1s, Internal trigger source).

1. To select output channel

Press **CH1|CH2** to select CH1. Now the boarder of the channel status bar is displayed in yellow.

2. To set the carrier waveform shape and amplitude for sweep

- 1) Waveform: Press **Sine** to select sine as the carrier waveform.
- 2) Amplitude: Press **Ampl/HiLevel** to highlight "Ampl", and then use the numeric keyboard to input 5. Then, select Vpp from the pop-up menu.

3. To enable sweep function

Press **Sweep** to enable the sweep function (the backlight of the key goes on).

- When **Sweep** is enabled, **Mod** or **Burst** function will be automatically disabled (if currently enabled).
- **Int** and **Sweep** will be displayed in the bottom of the screen.

4. To select sweep type

Press **Type** to select Linear. At this point, a white line appears on the waveform in the screen as shown in the right figure.



5. To set the start frequency and stop frequency

- 1) Start Frequency
Press **Start/Center** to highlight "Start", and then use the numeric keyboard to input "50". Then, select Hz from the pop-up menu.
- 2) Stop Frequency
Press **Stop/Span** to highlight "Stop", and then use the numeric keyboard to input 1. Then, select Hz from the pop-up menu.

6. To set the sweep time

Press **Sweep Time** to input 1 using the numeric keyboard and select sec from the pop-up menu.

7. To select the trigger source

Press **Trigger** → **Source** to select Int trigger source.

8. To enable the output

Press **Output1** to turn CH1 output on. At this point, the backlight goes on and the **[CH1]** connector outputs the sweep waveform based on the current settings.

9. To observe the output waveform

Connect the **[CH1]** connector to the oscilloscope using BNC cable. Now, you can observe the waveform via the oscilloscope.

To Output Burst Waveform

DG1000Z can output waveform with specified number of cycles (called burst) from a single channel or from dual channels at the same time. This section introduces how to output burst from the **[CH1]** connector (3 cycles, the carrier is sine with 5Vpp amplitude and 1ms period, Burst Period: 10ms, Internal trigger source, Delay: 1ms).

1. To select output channel

Press **CH1 | CH2** to select CH1. Now the border of the channel status bar is displayed in yellow.

2. To set the carrier waveform shape, amplitude and period for burst

- 1) Waveform: Press **Sine** to select sine as the carrier waveform.
- 2) Amplitude: Press **Ampl/HiLevel** to highlight "Ampl", and then use the numeric keyboard to input 5. Then, select Vpp from the pop-up menu.
- 3) Period: Press **Freq/Period** to highlight "Period", and then use the numeric keyboard to input 1. Then, select msec from the pop-up menu.

3. To enable burst function

Press **Burst** to enable the burst function (the backlight of the key goes on).

- When **Burst** is enabled, **Mod** or **Sweep** function will be automatically disabled (if currently enabled).
- **Int** and **Burst** will be displayed in the bottom of the screen.

4. To set the burst type and Cycles

Press **Type** to select NCycle. At this point, the Cycles in the screen is highlighted and can be edited. Use the numeric keyboard to input 3 and press **Sure**.

5. To set burst period

Burst period is only available for N cycle burst in internal trigger and is defined as the time from the start of a burst to the start of the next burst.

Press **Burst Period** to input 10 using the numeric keyboard and select msec from the pop-up menu.

6. To select burst trigger source

Press **Trigger** → **Source** to select Int trigger source.

7. To set the delay

Burst delay is only available for N cycle and infinite burst type. It is defined as the time from when the generator receives the trigger signal to starts to output the N Cycle (or Infinite) burst. Press **Delay**, and then use the numeric keyboard to input 1. Then select msec from the pop-up menu.

8. To enable the output

Press **Output1** to turn CH1 output on. At this point, the backlight goes on and the **[CH1]** connector outputs the burst waveform based on the current settings.

9. To observe the output waveform

Connect the **[CH1]** connector to the oscilloscope using BNC cable. The waveform is as shown in the figure below.

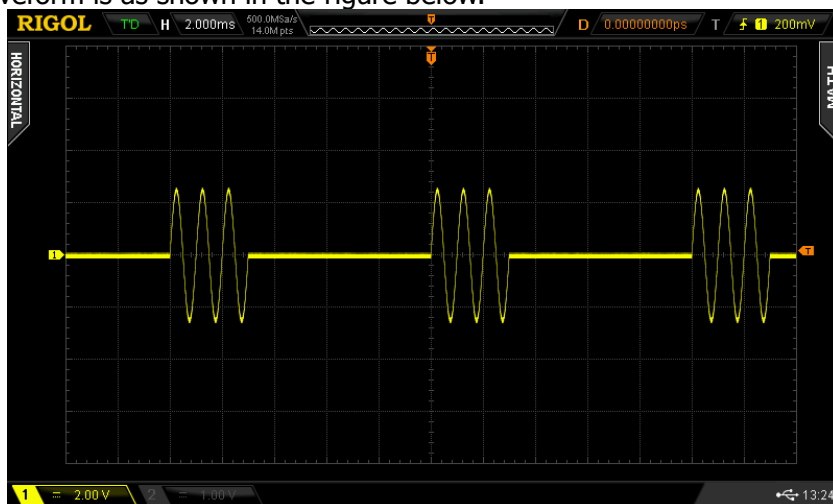



Figure 10 Burst Waveform

Remote Control

DG1000Z can communicate with PC through the USB, LAN or GPIB (option) interface to realize remote control on the basis of the SCPI commands (Standard Commands for Programmable Instruments). This section introduces how to control the generator remotely by sending the SCPI commands using **Ultra Sigma** provided by **RIGOL** via the USB interface. For detailed information about the commands, please refer to the Programming Guide.

When the instrument is working in remote mode, the  indicator is displayed in the screen and the keys (except **Help**) at the front panel are locked. Now you can return the instrument to local mode by pressing **Help**.

1. To install Ultra Sigma

Acquire the Ultra Sigma software and install it as well as its components according to the instructions. You can download the latest version of Ultra Sigma from **RIGOL** website.

2. To control the generator via USB

1) Connect the device

Connect the generator (USB Device) and PC (USB Host) using USB cable.

2) Install USB drive

This generator is USB-TMC device and the **New Hardware Wizard** will be displayed after the generator is correctly connected to the PC (the generator will be automatically configured to USB interface) and both of them are started. Please install the "USB Test and Measurement Device (IVI)" drive program according to the instructions.

3) Search for device resource

Start Ultra Sigma and the software will search for the generator resource currently connected to the PC automatically. You can also click

 to search for the resource manually.

4) View device resource

The resource found together with the instrument model and USB interface information will be displayed under the "RIGOL Online Resource" directory, as shown in Figure 11.



Figure 11 To View USB Instrument Resource

5) Communication test

Right-click the resource name DG1062Z

(USB0::0x1AB1::0x0642::DG1ZA000000000::INSTR) and select SCPI Panel Control to open the remote command control panel through which you can send commands and read data.



Figure 12 Send and Read Commands via USB

Troubleshooting

The commonly encountered failures and their solutions are listed below. When you encounter those problems, please solve them following the corresponding steps. If the problem remains still, please contact **RIGOL** and provide your device information (**Utility** → **System Info**).

- 1. The screen of the generator is still dark (no display) after pressing the power key:**
 - 1) Check whether the power is correctly connected.
 - 2) Check whether the power key is really pressed.
 - 3) Restart the instrument after finishing the above inspections.
 - 4) If it still does not work correctly, please contact **RIGOL**.

- 2. The screen is too dark and cannot be seen clearly:**
 - 1) Check whether the brightness setting of the LCD screen is too low.
 - 2) Press **Utility** → **System** → **Display** to enter the display setting menu. Press **Bright** and **Contrast** and use the numeric keyboard or the knob to adjust the brightness and contrast of the LCD screen to a proper value respectively.

- 3. The generator is locked:**
 - 1) Check whether the generator is in remote control mode (in remote control,  is displayed in the status bar of the user interface). Pressing **Help** can exit the remote control mode and unlock the front panel.
 - 2) Restarting the generator can also unlock the instrument.

- 4. The settings are correct but no waveform is generated:**
 - 1) Check if the BNC cable is tightly connected to the corresponding **[Output1]** or **[Output2]** connector.
 - 2) Check whether the connecting wire has internal damage.
 - 3) Check whether the BNC cable is tightly connected to the test instrument.
 - 4) Check whether the backlight of **Output1** or **Output2** goes on. If not, press corresponding key to illuminate the backlight.
 - 5) Press **Utility** → **System** → **Power On** to select Last and then restart the instrument after finishing the above inspections.
 - 6) If it does not work correctly, please contact **RIGOL**.

- 5. The USB storage device cannot be recognized:**
 - 1) Check whether the USB storage device can work normally when connected to other instrument or PC.
 - 2) Make sure that the USB storage device used is FAT32 format and Flash type. This instrument does not support hardware USB storage device.
 - 3) Restart the instrument and insert the USB storage again to check whether it can work normally.

- 4) If the USB storage device still cannot be used normally, please contact **RIGOL**.

6. How to set the amplitude of the waveform in dBm?

- 1) Press **CH1 | CH2** to select desired channel.
- 2) Check whether the setting in **Utility** → **Channel Set** → **Output Set** → **Imped** is HighZ. If yes, you cannot set the amplitude in dBm. Please press **Imped** to select Load and use the numeric keyboard or knob to set the impedance to a proper value.
- 3) Select desired waveform, press **Ampl/HiLevel** to highlight "Ampl", and then use the numeric keyboard to input desired value. Then select dBm from the pop-up menu.

7. Performance verification test is not passed:

- (1) Check whether the generator is within calibration period (1 year).
- (2) Make sure that the generator is warmed up for at least 30 minutes before test.
- (3) Check whether the generator is under the specified temperature.
- (4) Check whether the test is under the magnetic environment.
- (5) Check whether the power supplies of generator and test system have strong interference.
- (6) Check whether the performance of the test device meets the requirement.
- (7) Make sure that the test device is within calibration period.
- (8) Check whether the test device meets the required conditions of the manual.
- (9) Check whether all connections are tight.
- (10) Check whether all cables have internal damage.
- (11) Make sure that the operations conform to settings and processes which are required by the performance verification manual.
- (12) Check whether the error calculation is a mistake.
- (13) The definitions of "Typical Value" for this product should be correctly understood: the performance specification of this product under specified conditions.

For More Product Information

You can obtain the instrument information including model, serial number as well as software version numbers and view the installation status of all the options through **Utility** → **System Info**.

For more information about this instrument, refer to the relevant manuals by logging in to the official website of **RIGOL** (www.rigol.com) to download them.

G1000Z User's Guide: introduces the functions of the instrument and the operation methods, remote control methods, possible failures and solutions in using the instrument, the technical specifications, and order information.

G1000Z Programming Guide: provides detailed descriptions of SCPI commands and programming instances of the instrument.

G1000Z Datasheet: provides the main features and technical specifications of the instrument.

Contact Us

If you have any problem or requirement when using our products or this manual, please contact **RIGOL**.

E-mail: service@rigol.com

Websites: www.rigol.com